



AirPro®

Advanced Spraying Technology for Automotive, Metal, Wood,
Waterborne, High Wear and Adhesive Applications



PROVEN QUALITY. LEADING TECHNOLOGY.

AirPro Air Spray Gun

Advanced Spraying Technology

The AirPro air spray gun delivers exceptional spray performance while addressing your environmental and operator concerns - whether you're a custom shop or a high volume manufacturing facility.

- **Optimize spray performance** with our cutting edge aircap and nozzle design
- Choose from a **wide range of gun models** to meet the needs of your specific application
- Maximize operator comfort with our **lightweight** design, **low trigger force** and **ergonomic handle**
- **Reduce maintenance** and downtime with fewer gun parts



Versatile Aircaps

Meet the needs of your environment with three different air spray technologies. Graco's AirPro gun has the versatility and flexibility to accommodate a variety of applications to fit your spraying needs.

AirPro Spray Gun



HVLP



COMPLIANT



CONVENTIONAL

FINISH QUALITY

Good

Better

Best

TRANSFER EFFICIENCY

High

High

Medium

FLUID FLOW

Low

Medium

High

AIR FLOW

High

Low

Low

SUPERIOR QUALITY

Apply Superior Quality Finishes

With one of the best spray patterns in the industry, the AirPro gun is a real stand-out!

- Even material distribution through the spray pattern for optimum coverage
- Improved transfer efficiency through reduced air consumption
- Uniform air flow through reduced spray turbulence
- Enhanced atomization through material-specific aircaps

To test these key features, Graco uses multi-dimensional imaging to measure material spray density and material distribution.

- Red indicates dense particles
- Blue indicates dispersed particles

As shown in the picture, an even blue pattern throughout is desired at the spray target.

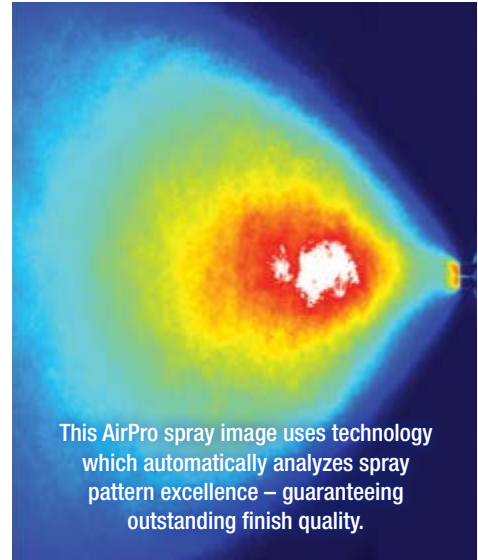

Maximize Operator Comfort and Increase Productivity

Ergonomically designed for superior handling, the AirPro guns maximize productivity by minimizing operator fatigue and discomfort:

- Well balanced and lightweight (410 grams) gun makes it easier to spray at a steady rate all day
- Ultra-light trigger pull reduces operator muscle stress
- Ergonomic gun handle provides a comfortable grip
- Rounded control knobs for operator comfort



ERGONOMIC

Applications



Wood

Aircaps and nozzles are specifically designed for wood finishing applications that require uniform material distribution at low pressures.

- Stains
- NGRs
- Toners

Needle/nozzle sizes available in 0.020", 0.030" and 0.040" (0.5, 0.8, and 1.0 mm).



Waterborne

Aircaps designed to spray environmentally friendly waterborne materials even with high solids content.

- Lacquers
- UV materials
- Paints

Needle/nozzle sizes available in 0.030", 0.042" and 0.055" (0.8, 1.1, and 1.4 mm).



Adhesive

Unique aircaps designed for spraying waterborne and solventborne adhesives and sealants.

For use in a variety of industries.

- Furniture
- Automotive
- Packaging

Needle/nozzle sizes in 0.051" and 0.70" (1.3 and 1.8 mm).



General Metal

The AirPro gun is ideal for metal parts fabricators and metal finishing shop operations requiring high quality paint jobs.

Works well with a wide variety of industrial coatings.

- Urethanes
- Epoxies
- Latex
- 2 component materials

Needle/nozzle sizes range from 0.020" up to 0.110" (0.5-2.8 mm).



High Wear

These guns are designed with a carbide nozzle and needle tip for long life with abrasive materials.

- Enamels
- Ceramics
- Metallics
- High solids



Available in 4 needle/nozzle sizes, 0.059", 0.070", 0.086" and 0.110" (1.5, 1.8, 2.2 and 2.8 mm).



Automotive

Whether painting a car, motorhome, truck or bus, the AirPro spray gun provides excellent atomization for Class A finishes.

It is optimized to paint:

- Base coats
- Clear coats
- Primers

Needle/nozzle sizes from 0.030" to 0.055" (0.8-1.4 mm).



Triton Packages

High Performance Finishing!

Superior Finish Quality

- Consistent pattern and film on parts.
- Constant flow to the spray gun.



TRITON pump provides 50% less pressure pulsation than standard diaphragm pumps.
Note: Pump-to-pump comparison without fluid regulator

Quality pumps enhance any finishing system. Paired with AirPro spray guns, the TRITON air-operated diaphragm spray package applies a high quality, decorative finish to wood and metal parts.

Triton is a more effective alternative to traditional pressure pots and standard diaphragm pumps.

High Quality Finish

Low pulsation output and smooth pump changeover deliver a consistent spray pattern.



Easy-to-use

Quick color changes and fast material refills save time and money.



Rugged Construction

Stainless steel or aluminum pump handles a wide variety of fluids.



Bold Union of Performance and Comfort

Combine spraying excellence with operator comfort and many other clever innovations, and you get the AirPro air spray gun from Graco. Ergonomically designed for superior handling, the AirPro guns have a soft, controlled and adjustable spray pattern with less overspray.

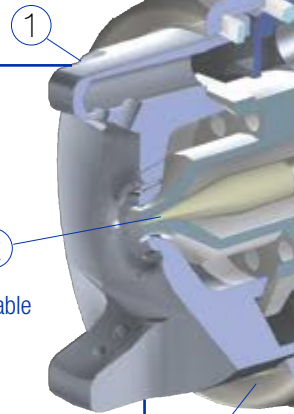

1. Aircaps in three air spray technologies to fit the needs of your environment
2. Two piece needle with replaceable tip reduces operating costs
3. Quick turn retaining ring which captures aircap upon disassembly
4. Long life needle packing for reduced downtime
5. Ultra-light trigger pull reduces operator fatigue
6. Inlet pressure adjustment (cheater) valve increases spraying flexibility
7. Air flow consumption designed to meet environmental compliance
8. Uniform air flow for reduced turbulence
9. Ergonomic knobs provide excellent operator comfort
10. One of the lightest weight (410 grams) guns in its category

APPRO® FEATURES

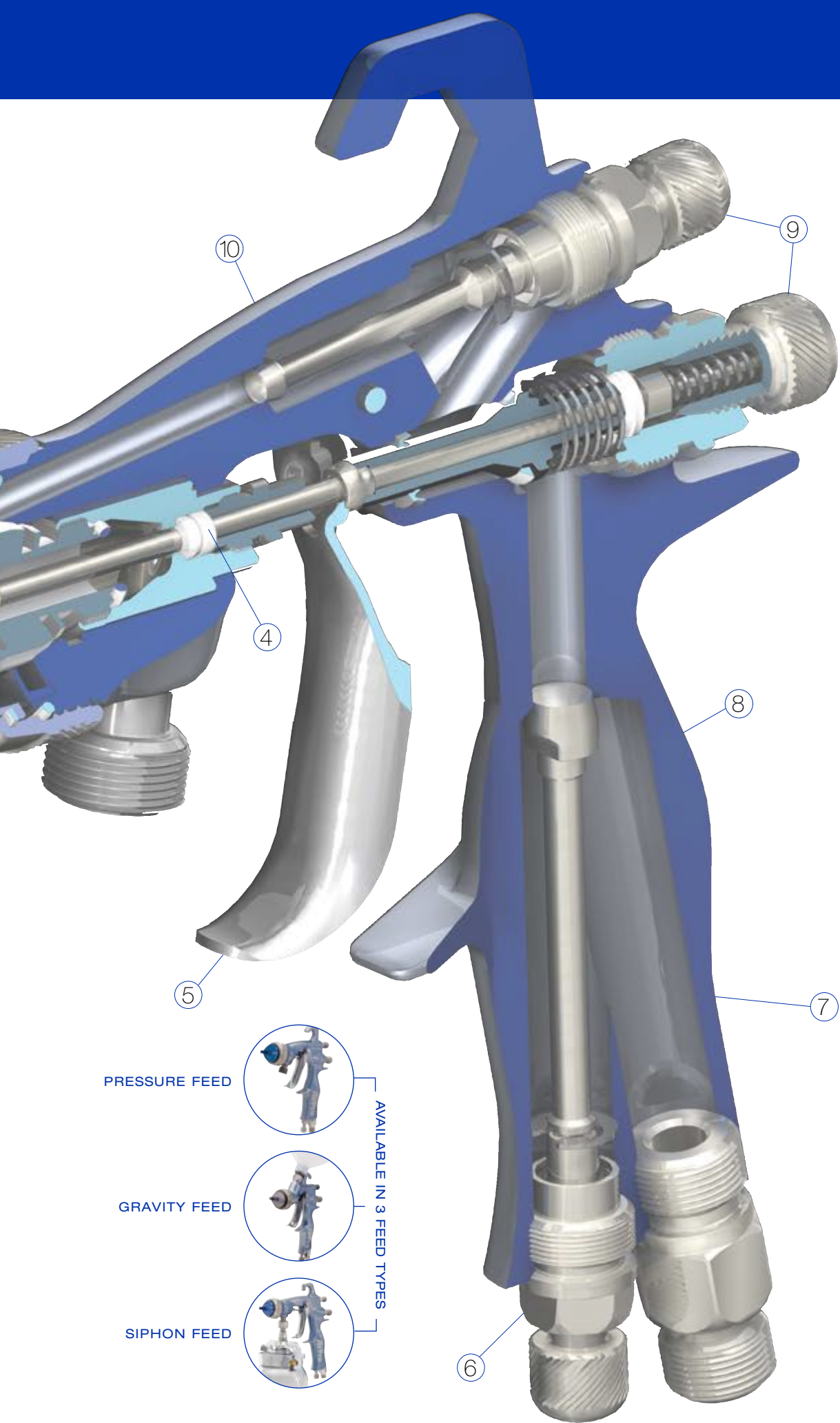

PRESSURE FEED



GRAVITY FEED



SIPHON FEED



AVAILABLE IN 3 FEED TYPES

Ordering Information

How To Order:

- ① Determine feed (pressure, gravity or siphon)
- ② If pressure feed, identify application type
- ③ Select spray type (conventional, HVLP or compliant)
- ④ Select material viscosity
- ⑤ Select average flow rate

MATERIAL VISCOSITY

VISCOSITY (centipoise)

Light	5-15
Light-Medium	15-30
Medium	30-70
Medium-Heavy	70-100
Heavy	>100

PRESSURE FEED General Metal Spray Guns



Part Number	Spray Type	Nozzle in. (mm)	Material Viscosity	Flow oz/min (l/min)	Aircap Kit	Needle/Nozzle Kit
288726	Conventional	0.020 (0.5)	light	4-8 (0.12-0.24)	289773	289458
288929	Conventional	0.030 (0.8)	light	4-12 (0.12-0.35)	289773	289459
288930	Conventional	0.042 (1.1)	light-medium	8-20 (0.24-0.59)	289773	289460
288931	Conventional	0.055 (1.4)	medium	16-30 (0.47-0.89)	289773	289462
288932	Conventional	0.070 (1.8)	medium-heavy	16-35 (0.47-1.04)	289784	289464
288933	Conventional	0.086 (2.2)	medium-heavy	16-40 (0.47-1.18)	289068	289466
288934	Conventional	0.110 (2.8)	heavy	16-45 (0.47-1.33)	289069	289467
288935	HVLP	0.020 (0.5)	light	4-8 (0.12-0.24)	289041	289458
288936	HVLP	0.030 (0.8)	light	4-10 (0.12-0.30)	289041	289459
288937	HVLP	0.042 (1.1)	light-medium	6-12 (0.18-0.35)	289041	289460
288938	HVLP	0.055 (1.4)	medium	12-18 (0.36-0.53)	289041	289462
288939	HVLP	0.070 (1.8)	medium-heavy	16-20 (0.47-0.59)	289041	289464
288940	HVLP	0.086 (2.2)	medium-heavy	18-22 (0.53-0.65)	289070	289466
288941	HVLP	0.110 (2.8)	heavy	20-24 (0.59-0.71)	289043	289467
288942	Compliant	0.020 (0.5)	light	4-8 (0.12-0.24)	289042	289458
288943	Compliant	0.030 (0.8)	light	4-10 (0.12-0.30)	289042	289459
288944	Compliant	0.042 (1.1)	light-medium	6-12 (0.18-0.35)	289042	289460
288945	Compliant	0.055 (1.4)	medium	12-18 (0.36-0.53)	289042	289462
288946	Compliant	0.070 (1.8)	medium-heavy	16-20 (0.47-0.59)	289042	289464
288947	Compliant	0.086 (2.2)	medium-heavy	18-22 (0.53-0.65)	289044	289466
288948	Compliant	0.110 (2.8)	heavy	20-24 (0.59-0.71)	289045	289467

General Metal with Stainless Steel Tip

Part Number	Spray Type	Nozzle in. (mm)	Material Viscosity	Flow oz/min (l/min)	Aircap Kit	Needle/Nozzle Kit
288949	Conventional	0.042 (1.1)	light-medium	8-20 (0.24-0.59)	289773	289461
288950	Conventional	0.055 (1.4)	medium	16-30 (0.47-0.89)	289773	289463
288951	Conventional	0.070 (1.8)	medium-heavy	16-35 (0.47-1.04)	289784	289465
288952	HVLP	0.042 (1.1)	light-medium	8-14 (0.24-0.41)	289041	289461
288953	HVLP	0.055 (1.4)	medium	12-16 (0.36-0.53)	289041	289463
288954	HVLP	0.070 (1.8)	medium-heavy	16-20 (0.47-0.59)	289041	289465
288955	Compliant	0.042 (1.1)	light-medium	8-14 (0.24-0.41)	289042	289461
288956	Compliant	0.055 (1.4)	medium	12-18 (0.36-0.53)	289042	289463
288957	Compliant	0.070 (1.8)	medium-heavy	16-20 (0.47-0.59)	289042	289465

Automotive Applications

Part Number	Spray Type	Nozzle in. (mm)	Material Viscosity	Flow oz/min (l/min)	Aircap Kit	Needle/Nozzle Kit
288929	Conventional	0.030 (0.8)	light	4-12 (0.12-0.35)	289773	289459
288930	Conventional	0.042 (1.1)	light-medium	8-20 (0.24-0.59)	289773	289460
24D472	Conventional	0.042 (1.1)	light-medium	8-20 (0.24-0.59)	289040	289460
288931	Conventional	0.055 (1.4)	medium	16-30 (0.47-0.89)	289773	289462
289034	HVLP	0.040 (1.0)	light	6-12 (0.18-0.35)	289771	289468
289035	HVLP	0.047 (1.2)	light-medium	10-14 (0.30-0.41)	289771	289469
289541	HVLP	0.055 (1.4)	medium	12-18 (0.36-0.53)	289771	289495
289036	Compliant	0.040 (1.0)	light	6-12 (0.18-0.35)	289772	289470
289037	Compliant	0.047 (1.2)	light-medium	10-14 (0.30-0.41)	289772	289471
289542	Compliant	0.055 (1.4)	medium	12-18 (0.36-0.53)	289772	289497

PRESSURE FEED Wood Applications



Part Number	Spray Type	Nozzle in. (mm)	Material Viscosity	Flow oz/min (l/min)	Aircap Kit	Needle/ Nozzle Kit
288958	Conventional	0.020 (0.5)	light	4-8 (0.12-0.24)	288862	289472
288959	Conventional	0.030 (0.8)	light	4-12 (0.12-0.35)	288862	289473
289109	Conventional	0.040 (1.0)	light	8-20 (0.24-0.59)	288862	289474
288960	HVLP	0.020 (0.5)	light	4-8 (0.12-0.24)	288864	289472
288961	HVLP	0.030 (0.8)	light	4-10 (0.12-0.30)	288864	289473
289110	HVLP	0.040 (1.0)	light	6-12 (0.18-0.35)	288864	289474
288962	Compliant	0.020 (0.5)	light	4-8 (0.12-0.24)	288863	289472
288963	Compliant	0.030 (0.8)	light	4-10 (0.12-0.30)	288863	289473
289111	Compliant	0.040 (1.0)	light	6-12 (0.18-0.35)	288863	289474

High Wear Applications

Part Number	Spray Type	Nozzle in. (mm)	Material Viscosity	Flow oz/min (l/min)	Aircap Kit	Needle/ Nozzle Kit
288973	Conventional	0.059 (1.5)	medium	16-35 (0.47-0.95)	288861	289478
288974	Conventional	0.070 (1.8)	medium-heavy	16-35 (0.47-1.04)	289049	289479
288975	Conventional	0.086 (2.2)	medium-heavy	16-40 (0.47-1.18)	289049	289480
289982	Conventional	0.110 (2.8)	heavy	16-45 (0.47-1.33)	289049	289980
288976	HVLP	0.059 (1.5)	medium	14-18 (0.41-0.53)	289115	289481
288977	HVLP	0.070 (1.8)	medium-heavy	16-20 (0.47-0.59)	289325	289482
288978	HVLP	0.086 (2.2)	medium-heavy	18-22 (0.53-0.65)	289325	289483
289983	HVLP	0.110 (2.8)	heavy	20-24 (0.59-0.71)	289325	289981
288979	Compliant	0.059 (1.5)	medium	14-18 (0.41-0.53)	289050	289481
288980	Compliant	0.070 (1.8)	medium-heavy	16-20 (0.47-0.59)	289327	289482
288981	Compliant	0.086 (2.2)	medium-heavy	18-22 (0.53-0.65)	289327	289483
289984	Compliant	0.110 (2.8)	heavy	20-24 (0.59-0.71)	289327	289981

Waterborne Applications

Part Number	Spray Type	Nozzle in. (mm)	Material Viscosity	Flow oz/min (l/min)	Aircap Kit	Needle/ Nozzle Kit
288964	Conventional	0.030 (0.8)	light	4-12 (0.12-0.35)	289046	289475
288965	Conventional	0.042 (1.1)	light-medium	8-20 (0.24-0.59)	289046	289476
288966	Conventional	0.055 (1.4)	medium	16-30 (0.47-0.89)	289046	289477
288967	HVLP	0.030 (0.8)	light	4-10 (0.12-0.30)	289047	289475
288968	HVLP	0.042 (1.1)	light-medium	8-14 (0.24-0.41)	289047	289476
288969	HVLP	0.055 (1.4)	medium	12-18 (0.36-0.53)	289047	289477
288970	Compliant	0.030 (0.8)	light	4-10 (0.12-0.30)	289048	289475
288971	Compliant	0.042 (1.1)	light-medium	8-14 (0.24-0.41)	289048	289476
288972	Compliant	0.055 (1.4)	medium	12-18 (0.36-0.53)	289048	289477

Adhesive Applications

Part Number	Spray Type	Nozzle in. (mm)	Material Viscosity	Flow oz/min (l/min)	Aircap Kit	Needle/ Nozzle Kit
288982	Conventional	0.051 (1.3)	medium	14-25 (0.41-0.74)	289051	289484
288983	Conventional	0.070 (1.8)	medium-heavy	16-35 (0.47-1.04)	289051	289485

Spatter Applications

Part Number	Spray Type	Nozzle in. (mm)	Material Viscosity	Flow oz/min (l/min)	Aircap Kit	Needle/ Nozzle Kit
288985	HVLP	0.042 (1.1)	light-medium	8-14 (0.24-0.41)	289053	289460

Air Brush Applications

Part Number	Spray Type	Nozzle in. (mm)	Material Viscosity	Flow oz/min (l/min)	Aircap Kit	Needle/ Nozzle Kit
24F202	Conventional	0.042 (1.1)	light-medium	8-14 (0.24-0.41)	24D705	289460



Ordering Information

GRAVITY FEED Without Cup



Part Number	Spray Type	Nozzle in. (mm)	Material Viscosity	Flow oz/min (l/min)	Aircap Kit	Needle/ Nozzle Kit
289002	Conventional	0.055 (1.4)	light-medium	4-10 (0.12-0.30)	289773	289493
289003	Conventional	0.070 (1.8)	light-medium	8-12 (0.24-0.36)	289773	289494
289005	HVLP	0.055 (1.4)	light-medium	3-5 (0.09-0.15)	289771	289495
289006	HVLP	0.070 (1.8)	light-medium	4-6 (0.12-0.18)	289771	289496
289008	Compliant	0.055 (1.4)	light-medium	3-5 (0.09-0.15)	289772	289497
289009	Compliant	0.070 (1.8)	light-medium	4-6 (0.12-0.18)	289772	289498

With Plastic Gravity Cup

Part Number	Spray Type	Nozzle in. (mm)	Material Viscosity	Flow oz/min (l/min)	Aircap Kit	Needle/ Nozzle Kit
289011	Conventional	0.055 (1.4)	light-medium	4-10 (0.12-0.30)	289773	289493
289012	Conventional	0.070 (1.8)	light-medium	8-12 (0.24-0.36)	289773	289494
289014	HVLP	0.055 (1.4)	light-medium	3-5 (0.09-0.15)	289771	289495
289015	HVLP	0.070 (1.8)	light-medium	4-6 (0.12-0.18)	289771	289496
289017	Compliant	0.055 (1.4)	light-medium	3-5 (0.09-0.15)	289772	289497
289018	Compliant	0.070 (1.8)	light-medium	4-6 (0.12-0.18)	289772	289498

With 3M™ PPS™ Cup

Part Number	Spray Type	Nozzle in. (mm)	Material Viscosity	Flow oz/min (l/min)	Aircap Kit	Needle/ Nozzle Kit
289020	Conventional	0.055 (1.4)	light-medium	4-10 (0.12-0.30)	289773	289493
289021	Conventional	0.070 (1.8)	light-medium	8-12 (0.24-0.36)	289773	289494
289023	HVLP	0.055 (1.4)	light-medium	3-5 (0.09-0.15)	289771	289495
289024	HVLP	0.070 (1.8)	light-medium	4-6 (0.12-0.18)	289771	289496
289026	Compliant	0.055 (1.4)	light-medium	3-5 (0.09-0.15)	289772	289497
289027	Compliant	0.070 (1.8)	light-medium	4-6 (0.12-0.18)	289772	289498

SIPHON FEED Without Siphon Cup*



Part Number	Spray Type	Nozzle in. (mm)	Material Viscosity	Flow oz/min (l/min)	Aircap Kit	Needle/ Nozzle Kit
289991	Conventional	0.055 (1.4)	light-medium	4-10 (0.12-0.30)	289769	289487
289992	Conventional	0.070 (1.8)	light-medium	8-12 (0.24-0.36)	289769	289488
289993	HVLP	0.055 (1.4)	light-medium	3-5 (0.09-0.15)	289435	289489
289994	HVLP	0.070 (1.8)	light-medium	4-6 (0.12-0.18)	289435	289490
289995	Compliant	0.055 (1.4)	light-medium	3-5 (0.09-0.15)	289768	289491
289996	Compliant	0.070 (1.8)	light-medium	4-6 (0.12-0.18)	289768	289492

* Purchase 3M™ PPS™ cup or aluminum cup separately

With Metal Siphon Cup

Part Number	Spray Type	Nozzle in. (mm)	Material Viscosity	Flow oz/min (l/min)	Aircap Kit	Needle/ Nozzle Kit
289028	Conventional	0.055 (1.4)	light-medium	4-10 (0.12-0.30)	289769	289487
289029	Conventional	0.070 (1.8)	light-medium	8-12 (0.24-0.36)	289769	289488
289030	HVLP	0.055 (1.4)	light-medium	3-5 (0.09-0.15)	289435	289489
289031	HVLP	0.070 (1.8)	light-medium	4-6 (0.12-0.18)	289435	289490
289032	Compliant	0.055 (1.4)	light-medium	3-5 (0.09-0.15)	289768	289491
289033	Compliant	0.070 (1.8)	light-medium	4-6 (0.12-0.18)	289768	289492

NEEDLE TIP IDENTIFICATION

Select needle tips for the AirPro guns now have markings for identification. The PEEK tips have grooves at the base to indicate its size.



5-Pack Part Number	Needle Tip Size in (mm)	# of Grooves
289350	0.020 (0.5)	1
288183	0.030 (0.8)	2
288184	0.040-0.042 (1.0-1.1)	3
288185	0.051-0.055 (1.3-1.4)	4
288187	0.070 (1.8)	5
288984	Siphon Conv/Compliant	6
289001	Gravity and Siphon HVLP	7

Tips without Grooves

5-Pack Part Number	Needle Tip Size in (mm)	Material of Construction
289004	0.086 (2.2)	PEEK
289007	1.10 (2.8)	PEEK
24E484	0.030 (0.8)	Stainless Steel
289010	0.042 (1.1)	Stainless Steel
289013	0.055-0.070 (1.4-1.8)	Stainless Steel

Accessories & Technical Specifications

HOSE

- 239631 4 ft (1.2 m) Air Whip Hose Assembly**
Max. working pressure: 100 psi (0.7 MPa, 7 bar).
ID: 5/16 in (7.9 mm) Swivel: 1/4 npsm(f), nitrile
- 239636 15 ft (4.6 m) Air Hose Assembly**
Max. working pressure: 100 psi (0.7 MPa, 7 bar).
ID: 5/16 in (7.9 mm) Swivel: 1/4 npsm(f), nitrile
- 239637 25 ft (7.6 m) Air Hose Assembly**
Max. working pressure: 100 psi (0.7 MPa, 7 bar).
ID: 5/16 in (7.9 mm) Swivel: 1/4 npsm(f), nitrile
- 239655 Air Swivel Inlet Fitting**
- 239622 4 ft (1.2m) Fluid Whip Hose Assembly**
Max. working pressure: 100 psi (0.7 MPa, 7 bar).
ID: 3/16 in (4.8 mm). 3/8 npsm(fbe), nylon with polyurethane cover
- 239633 15 ft (4.6 m) Fluid Hose Assembly**
Max. working pressure: 100 psi (0.7 MPa, 7 bar).
ID: 3/16 in (4.8 mm). 3/8 npsm(fbe), nylon with polyurethane cover
- 239634 25 ft (7.6 m) Fluid Hose Assembly**
Max. working pressure: 100 psi (0.7 MPa, 7 bar).
ID: 3/16 in (4.8 mm). 3/8 npsm(fbe), nylon with polyurethane cover

AIR VALVES

- 234784 Air Control Valve Kit (Cheater Valve) with Gauge**
Attaches to any HVLP spray gun for precise air pressure setting with a 0-160 psi gauge
- 235119 Gun Air Regulator Assembly 0-100 psi**

SIPHON FEED GUN KITS

- 24C173 0.086 in (2.2 mm) Conventional Aircap**
- 24C175 0.086 in (2.2 mm) Conventional Needle and Nozzle Kit**

CLEANING KITS

- 105749 Cleaning Brush**
- 111265 4 oz Gun Lubricant (non-silicone)**
- 15C161 Ultimate Gun Cleaning Kit**
Includes brushes and tools for maintenance



AIR PRESSURE VERIFICATION KIT

For use in checking aircap atomizing air pressure. Not to be used for actual spraying. Note: To be HVLP compliant, the atomizing air pressure must not exceed 10 psi (70 MPa, 0.7 bar).

ORIFICE SIZE IN INCHES (mm)

- 289563** General Metal 0.020–0.070 in (0.5–1.8 mm)
- 289564** General Metal 0.086 in (2.2 mm)
- 289565** General Metal 0.110 (2.8 mm)
- 289566** Wood
- 289567** Waterborne
- 289568** High Wear 0.059 in (1.5 mm)
- 289569** High Wear 0.070–0.086 in (1.8–2.2 mm)
- 289803** Automotive and Gravity Feed
- 289589** Siphon Feed

GRAVITY, SIPHON AND PRESSURE CUPS

- 289770 23 oz (650 cc) Gravity Cup, Plastic**
- 289797 23 oz (650 cc) Gravity Cup, Aluminum**
- 289802 34 oz (1 l) Gravity Cup, Aluminum**
- 192407 Gravity Cup Holder**
- 244130 1 qt (0.9 l) Siphon Cup, Aluminum**
- 239802 1 qt (0.9 l) SST Pressure Cup with Single Air Regulator**
Includes a pressure relief valve and a single cup air regulator and gauge.
- 239803 1 qt (0.9 l) SST Pressure Cup with Double Air Regulator**
Includes a pressure relief valve, a 0-100 psi (0-0.7 MPa, 0-7 bar) air regulator for gun atomization, and 0-15 psi (0-104 kPa, 0-1.0 bar) air regulator for the cup air supply.
- 239804 1 qt (0.9 l) Remote SST Pressure Cup**
Includes air pressure regulator and gauge, 4 ft (1.2 m) length air and fluid hose with 1/4 npsm(f) swivel ends, pressure relief valve and rigid hook handle.
- 288776 2 qt (1.9 l) Remote Aluminum Pressure Cup**
- 240266 Disposable Polyethylene Cup Liners**
1 qt (0.9 l) capacity, paint and solvent resistant. Must be used with pressure and siphon cups. 40 liners.

3M's PPS™ Paint Preparation System Accessories from Graco

For use with gravity and siphon feed guns

- 6 oz (150 ml) 3M™ PPS™**
- 234941 Cup and Collar** (box of 8)
- 234940 Lid and Liner** (box of 50)
- 234942 Measurement Insert** (box of 50)

- 25 oz (650 ml) 3M™ PPS™**
- 234771 Cup and Collar** (box of 8)
- 234772 Lid and Liner** (box of 50)
- 15F531 Measurement Insert** (box of 100)

- 32 oz (850 ml) 3M™ PPS™**
- 234937 Cup and Collar** (box of 4)
- 234938 Lid and Liner** (box of 25)
- 234939 Measurement Insert** (box of 100)

- 289486 Gravity Kit (25 oz)**
One each: cup, collar, lid, liner, adapter
- 289795 3M™ PPS™ Gravity Feed Adapter**

- 234773 Siphon Kit (25 oz)**
One each: cup, collar, lid, liner, adapter
- 289405 3M™ PPS™ Siphon Feed Adapter**

- 310693 Instruction Manual**



Technical Specifications

Maximum Air Inlet Pressure.....	100 psi (0.7 MPa, 7 bar)
Maximum Fluid Inlet Pressure	300 psi (2.1 MPa, 21 bar)
Maximum HVLP/Compliant Inbound Air Pressure*	
HVLP**	19-30 psi (0.1-0.21 MPa, 1.3-2.1 bar)
Compliant**	29-35 psi (0.2-0.24 MPa, 2.0-2.4 bar)
Air Consumption	
Conventional General Metal @ 36 psi (0.25 MPa, 2.5 bar)	12.6 cfm
HVLP General Metal @ 19 psi (0.13 MPa, 1.3 bar)	14.9 cfm
Compliant General Metal @ 29 psi (0.2 MPa, 2.0 bar)	11.7 cfm

Fluid and Air Operating Temperature Range	32°-109°F (0°-43°C)
Weight	410 g (14.46 oz)
Air Inlet	1/4 npsm (R1/4-19)
Fluid Inlet	3/8 npsm (R3/8-19)
Wetted Parts	303 SST, 17-4 PH SST, PEEK, acetal, UHMWPE
Instruction manual	
Pressure Feed	312414
Gravity Feed	312579
Siphon Feed	312578

* Produces 10 psi (0.07 MPa, 0.7 bar) spraying pressure at aircap
** Dependent on application type



ABOUT GRACO

PROVEN QUALITY. LEADING TECHNOLOGY.

Founded in 1926, Graco is a world leader in fluid handling systems and components. Graco products move, measure, control, dispense and apply a wide range of fluids and viscous materials used in vehicle lubrication, commercial and industrial settings.

The company's success is based on its unwavering commitment to technical excellence, world-class manufacturing and unparalleled customer service. Working closely with qualified distributors, Graco offers systems, products and technology that set the quality standard in a wide range of fluid handling solutions. Graco provides equipment for spray finishing, protective coating, paint circulation, lubrication, and dispensing sealants and adhesives, along with power application equipment for the contractor industry. Graco's ongoing investment in fluid management and control will continue to provide innovative solutions to a diverse global market.

GRACO LOCATIONS

MAILING ADDRESS

P.O. Box 1441
Minneapolis, MN 55440-1441
Tel: 612-623-6000
Fax: 612-623-6777

AMERICAS

MINNESOTA

Worldwide Headquarters
Graco Inc.
88-11th Avenue N.E.
Minneapolis, MN 55413

EUROPE

BELGIUM

European Headquarters
Graco N.V.
Industrieterrein-Oude Bunders
Slakweidestraat 31
3630 Maasmechelen,
Belgium
Tel: 32 89 770 700
Fax: 32 89 770 777

ASIA PACIFIC

AUSTRALIA

Graco Australia Pty Ltd.
Suite 17, 2 Enterprise Drive
Bundoora, Victoria 3083
Australia
Tel: 61 3 9468 8500
Fax: 61 3 9468 8599

CHINA

Graco Hong Kong Ltd.
Shanghai Representative Office
Building 7
1029 Zhongshan Road South
Huangpu District
Shanghai 200011
The People's Republic of China
Tel: 86 21 649 50088
Fax: 86 21 649 50077

INDIA

Graco Hong Kong Ltd.
India Liaison Office
Room 443, Augusta Point
Regus Business Centre 53
Golf Course Road
Gurgaon, Haryana
India 122001
Tel: 91 124 435 4208
Fax: 91 124 435 4001

JAPAN

Graco K.K.
1-27-12 Hayabuchi
Tsuzuki-ku
Yokohama City, Japan 2240025
Tel: 81 45 593 7300
Fax: 81 45 593 7301

KOREA

Graco Korea Inc.
Shinhan Bank Building
4th Floor #1599
Gwanyang-Dong, Dongan-Ku,
Anyang-si, Korea 431-060
Tel: 82 31 476 9400
Fax: 82 31 476 9801

SALES/ DISTRIBUTION/ SERVICE

Call today for product information or to request a demonstration.

877-84GRACO (1-877-844-7226) or visit us at www.graco.com.

Graco Inc. is registered to I.S. EN ISO 9001

North America
Customer Service
800-328-0211
Fax 877-340-6427