

# PD44

313877E  
EN

## Control Box

---

***Meter, mix and dispense system for precise two-component micro-dispensing of sealants and adhesives. Not for use in explosive atmospheres.***



### **Important Safety Instructions**

Read all warnings and instructions in this manual. Save these instructions.

See page 3 for model information, including maximum working pressure and approvals.

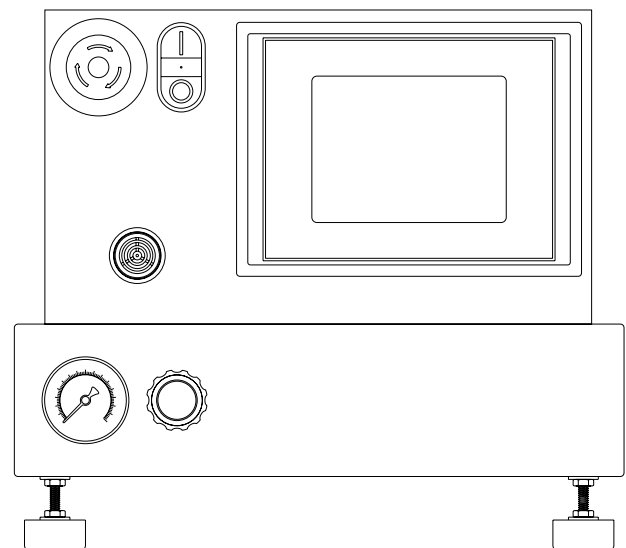

*Micrometer PD44 and LRT PD44 Control Box shown*

# Contents

<b>Related Manuals</b> .....	<b>3</b>	<b>Pressure Relief Procedure</b> .....	<b>38</b>
<b>Models</b> .....	<b>3</b>	<b>Shutdown</b> .....	<b>38</b>
<b>Warnings</b> .....	<b>4</b>	<b>Optional Customer Inputs</b> .....	<b>39</b>
<b>Component Identification</b> .....	<b>6</b>	<b>Maintenance</b> .....	<b>40</b>
Control Boxes .....	6	<b>Troubleshooting</b> .....	<b>40</b>
PD44 Dispense Valve .....	8	<b>Technical Data</b> .....	<b>41</b>
<b>Grounding</b> .....	<b>9</b>	<b>Graco Standard Warranty</b> .....	<b>42</b>
<b>Setup</b> .....	<b>10</b>	<b>Graco Information</b> .....	<b>42</b>
Micrometer and LRT PD44 Only .....	10		
Motor Driven PD44 Only .....	11		
<b>Startup</b> .....	<b>12</b>		
<b>Dispensing Operation</b> .....	<b>13</b>		
<b>HMI Operation</b> .....	<b>14</b>		
Screen Navigation Diagrams .....	14		
Main Screen .....	16		
Posidot Control Screen (Micrometer PD44 and LRT PD44 only) .....	17		
Metering Valve Control Screen (Motor Driven PD44 only) .....	18		
Shot Size Screen (LRT PD44 only) .....	20		
Shot Size Screen (Motor Driven PD44 Only) .....	21		
Level 1 Control Screen .....	22		
Level 2 Control Screen .....	23		
Purge Timer Screen .....	25		
Status Screen .....	28		
Motor Status Screen (Motor Driven PD44 only) .....	30		
Motor Error Codes Screen (Motor Driven PD44 Only) .....	32		
Supervisor Screen (LRT PD44 Only) .....	33		
Supervisor Screen (Motor Driven PD44 Only) .....	34		
Supervisor Help Screen (Motor Driven PD44 Only) .....	35		
Calibration Screen (LRT PD44 Only) .....	36		

## Related Manuals

PD44 Manuals	
Part	Description
313876	PD44 Dispense Valve Operation - Parts
Feed System Manuals	
306565	Air-Driven, Stainless Steel Agitators
307043	Monark <sup>®</sup> Air Motor
308116	Severe-Duty, UHMWPE/PTFE or PTFE Packed Stainless Steel Pumps
308167	Low Volume Air Regulators
308168	High Volume Air Regulators
308169	Air Filters, Lubricators and Kits
309306	Air-Operated Husky <sup>™</sup> Diaphragm Pumps
312376	Stainless Steel Agitator Kit
313526	Check-Mate <sup>®</sup> Pump Packages
406088	Check-Mate <sup>®</sup> Ram Packages





## Models

PD44 Control Box Model	Max Air Working Pressure psi (MPa, bar)	Voltage	CE Approved*
Linear Resistive Transducer (LRT)	100 (0.7, 7)	120/240V, 50/60Hz	✓
Micrometer	100 (0.7, 7)	120/240V, 50/60Hz	✓
Motor Driven	100 (0.7, 7)	120/240V, 50/60Hz	✓

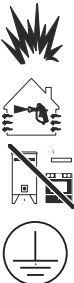

\* If a custom PD44 is ordered, it will not be CE approved unless otherwise noted.

# Warnings

The following warnings are for the setup, use, grounding, maintenance, and repair of this equipment. The exclamation point symbol alerts you to a general warning and the hazard symbol refers to procedure-specific risk. Refer back to these warnings. Additional, product-specific warnings may be found throughout the body of this manual where applicable.

 <b>WARNING</b>	
	<p><b>TOXIC FLUID OR FUMES HAZARD</b></p> <p>Toxic fluids or fumes can cause serious injury or death if splashed in the eyes or on skin, inhaled, or swallowed.</p> <ul style="list-style-type: none"> <li>• Read MSDS's to know the specific hazards of the fluids you are using.</li> <li>• Store hazardous fluid in approved containers, and dispose of it according to applicable guidelines.</li> <li>• Always wear impervious gloves when spraying or cleaning equipment.</li> <li>• If this equipment is used with isocyanate material, see additional information on isocyanates in Iso-cyanate Conditions Section of this manual.</li> </ul>
	<p><b>PERSONAL PROTECTIVE EQUIPMENT</b></p> <p>You must wear appropriate protective equipment when operating, servicing, or when in the operating area of the equipment to help protect you from serious injury, including eye injury, inhalation of toxic fumes, burns, and hearing loss. This equipment includes but is not limited to:</p> <ul style="list-style-type: none"> <li>• Protective eyewear</li> <li>• Clothing and respirator as recommended by the fluid and solvent manufacturer</li> <li>• Gloves</li> <li>• Hearing protection</li> </ul>
	<p><b>FIRE AND EXPLOSION HAZARD</b></p> <p>Flammable fumes, such as solvent and paint fumes, in <b>work area</b> can ignite or explode. To help prevent fire and explosion:</p> <ul style="list-style-type: none"> <li>• Use equipment only in well ventilated area.</li> <li>• Eliminate all ignition sources; such as pilot lights, cigarettes, portable electric lamps, and plastic drop cloths (potential static arc).</li> <li>• Keep work area free of debris, including solvent, rags and gasoline.</li> <li>• Do not plug or unplug power cords, or turn power or light switches on or off when flammable fumes are present.</li> <li>• Ground all equipment in the work area. See <b>Grounding</b> instructions.</li> <li>• Use only grounded hoses.</li> <li>• Hold gun firmly to side of grounded pail when triggering into pail.</li> <li>• If there is static sparking or you feel a shock, <b>stop operation immediately</b>. Do not use equipment until you identify and correct the problem.</li> <li>• Keep a working fire extinguisher in the work area.</li> </ul>
	<p><b>ELECTRIC SHOCK HAZARD</b></p> <p>This equipment must be grounded. Improper grounding, setup, or usage of the system can cause electric shock.</p> <ul style="list-style-type: none"> <li>• Turn off and disconnect power cord before servicing equipment.</li> <li>• Use only grounded electrical outlets.</li> <li>• Use only 3-wire extension cords.</li> <li>• Ensure ground prongs are intact on power and extension cords.</li> <li>• Do not expose to rain. Store indoors.</li> </ul>

**WARNING**

	<p><b>PRESSURIZED EQUIPMENT HAZARD</b></p> <p>Fluid from the gun/dispense valve, leaks, or ruptured components can splash in the eyes or on skin and cause serious injury.</p> <ul style="list-style-type: none"> <li>• Follow <b>Pressure Relief Procedure</b> in this manual, when you stop spraying and before cleaning, checking, or servicing equipment.</li> <li>• Tighten all fluid connections before operating the equipment.</li> <li>• Check hoses, tubes, and couplings daily. Replace worn or damaged parts immediately.</li> </ul>
	<p><b>EQUIPMENT MISUSE HAZARD</b></p> <p>Misuse can cause death or serious injury.</p> <ul style="list-style-type: none"> <li>• Do not operate the unit when fatigued or under the influence of drugs or alcohol.</li> <li>• Do not exceed the maximum working pressure or temperature rating of the lowest rated system component. See <b>Technical Data</b> in all equipment manuals.</li> <li>• Do not leave the work area while equipment is energized or under pressure. Turn off all equipment and follow the <b>Pressure Relief Procedure</b> in this manual when equipment is not in use.</li> <li>• Check equipment daily. Repair or replace worn or damaged parts immediately with genuine manufacturer's replacement parts only.</li> <li>• Do not alter or modify equipment.</li> <li>• Use equipment only for its intended purpose. Call your distributor for information.</li> <li>• Route hoses and cables away from traffic areas, sharp edges, moving parts, and hot surfaces.</li> <li>• Do not kink or over bend hoses or use hoses to pull equipment.</li> <li>• Keep children and animals away from work area.</li> <li>• Comply with all applicable safety regulations.</li> </ul>
	<p><b>PLASTIC PARTS CLEANING SOLVENT HAZARD</b></p> <p>Use only compatible water-based solvents to clean plastic structural or pressure-containing parts. Many solvents can degrade plastic parts and cause them to fail, which could cause serious injury or property damage. See <b>Technical Data</b> in this and all other equipment instruction manuals. Read fluid and solvent manufacturer's warnings.</p>

# Component Identification

## Control Boxes

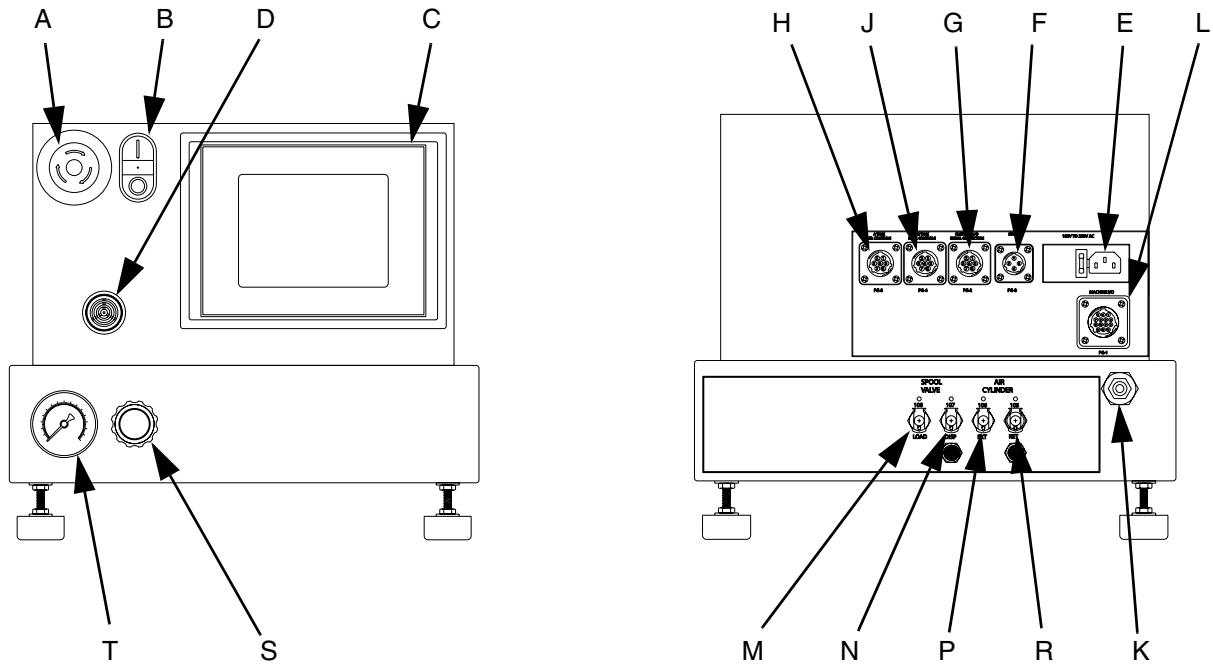

**Key:**

- A Emergency Stop
- B Control Power Switch
- C Touch Panel
- D Alarm Speaker
- E Power Input
- F Start Options Connection
- G Custom I/O
- H A Tank Level Controls Connection
- J B Tank Level Controls Connection

- K Main Air Inlet
- L Dispense Valve I/O Connection
- M Spool Valve Load Connection
- N Spool Valve Dispense Connection
- P Air Cylinder Extend Connection
- R Air Cylinder Retract Connection
- S Air Pressure Regulator
- T Air Pressure Gauge

**FIG. 1: Micrometer and LRT PD44 Control Box**

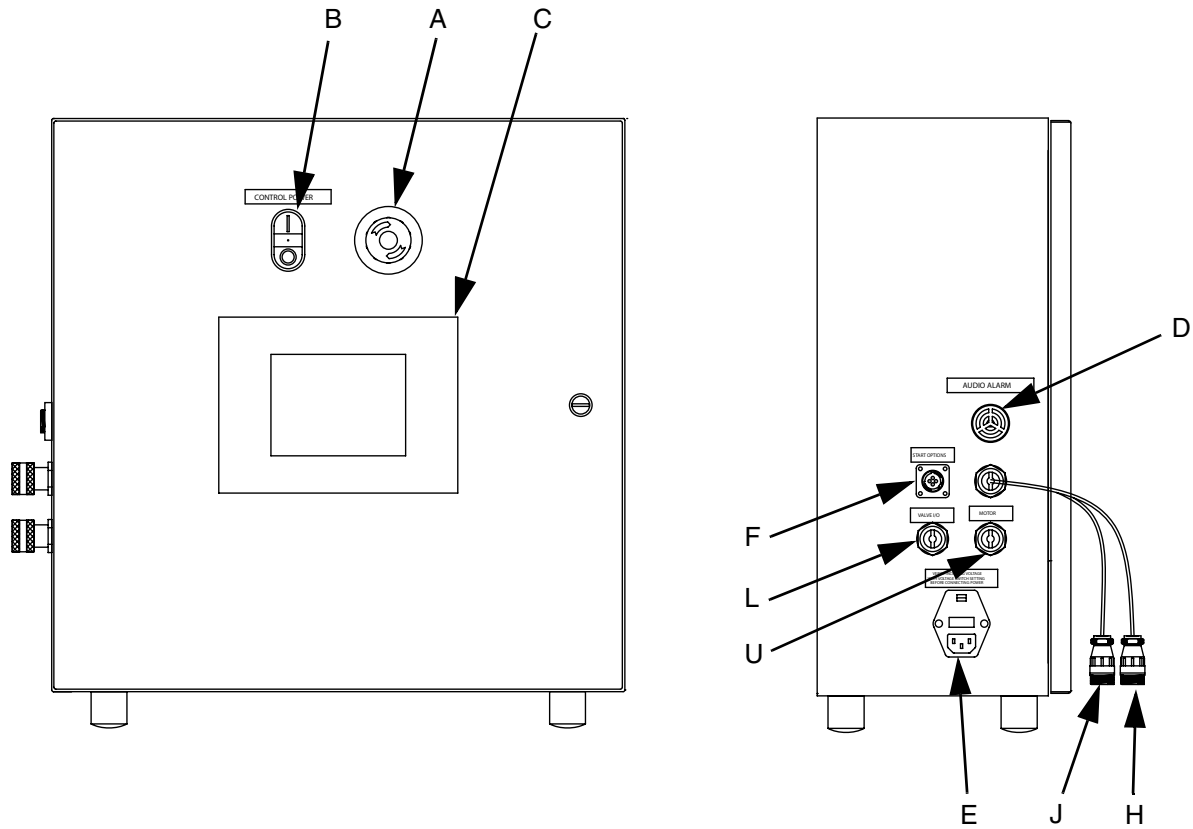

- Key:**
- A Emergency Stop
  - B Control Power Switch
  - C Touch Panel

- D Alarm Speaker
- E Power Input
- F Start Options Connection
- H A Tank Level Controls Connection
- J B Tank Level Controls Connection
- L Dispense Valve I/O Connection
- U Motor Connection

**FIG. 2: Motor Driven PD44 Control Box**

## PD44 Dispense Valve

See PD44 Operation manual 313876 for detailed dispense valve component identification and instructions.

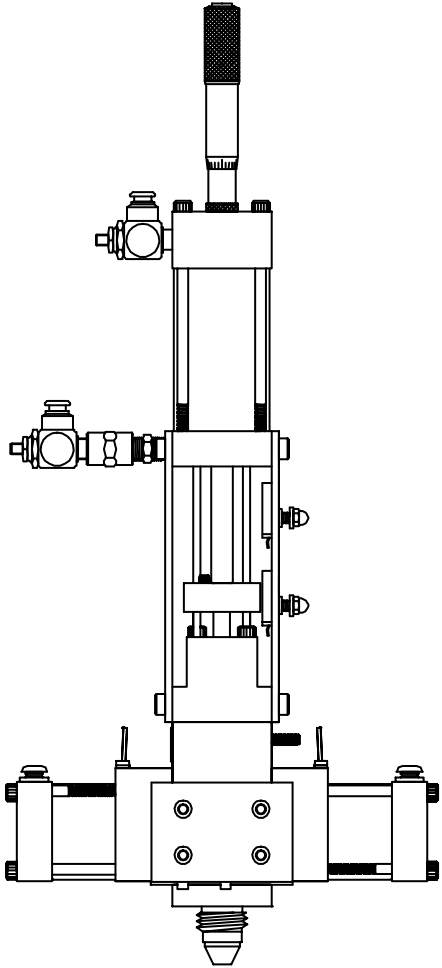
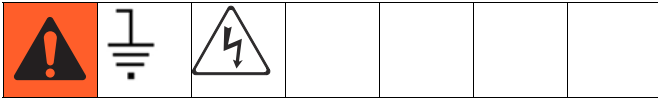

**FIG. 3: PD44 Micrometer Dispense Valve**

---



# Grounding



This product must be grounded. In the event of an electrical short circuit, grounding reduces the risk of electric shock by providing an escape wire for the electric current.

**Grounding plug units:** this product is equipped with a cord having a grounding wire with an appropriate grounding plug. The plug must be plugged into an outlet that is properly installed and grounded in accordance with all local codes and ordinances.

**Hard-wired units:** the grounding wire must be used. All electrical wiring must be done by a qualified electrician and comply with all local codes and regulations.

**Air and fluid hoses:** use only electrically conductive hoses.

**Fluid supply container:** follow local code.

**Solvent pails used when flushing:** follow local code. Use only conductive metal pails, placed on a grounded surface. Do not place the pail on a non-conductive surface, such as paper or cardboard, which interrupts grounding continuity.

# Setup

## Micrometer and LRT PD44 Only

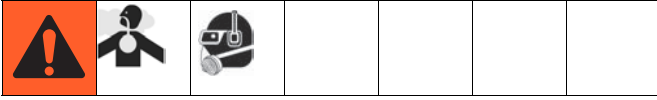

1. Connect air supply to main air inlet on control box. Air supply must include a shut-off/bleed valve that bleeds pressure past the shut-off/bleed valve and an air-water separator/filter.

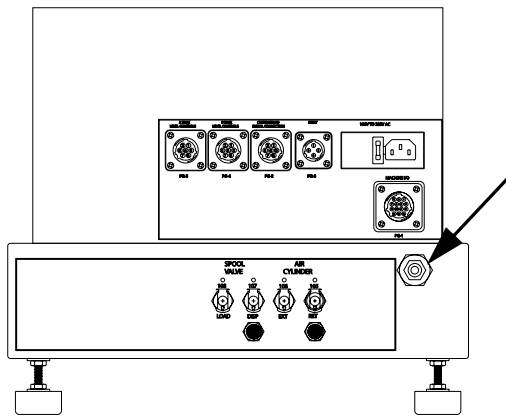

2. Connect air lines from control box to dispense valve. Match the number and color codes on the fittings and connections. See the following table and illustration.

Connection Color	Connection Description
Red	Extend
Blue	Retract
Yellow	Dispense
Green	Reload

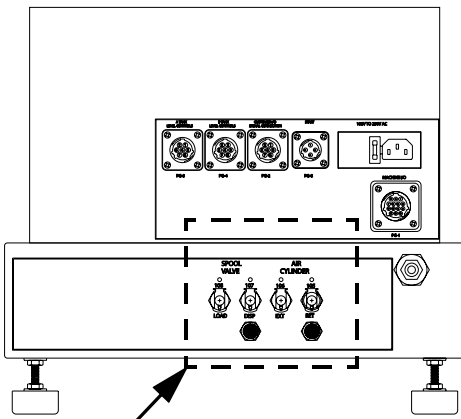

3. Connect Dispense Valve I/O, and Start Options logic cables. If level controls are installed, connect Level Controls logic cables.

**NOTICE**

Feed system and main logic control system must use separate air supplies.

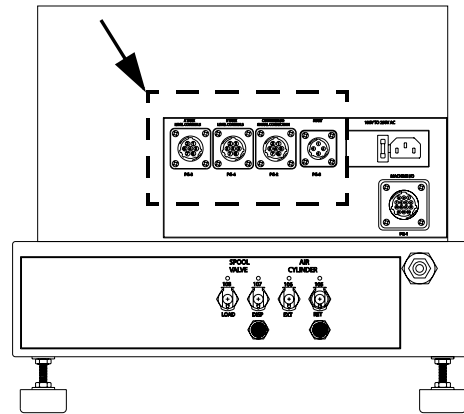

4. Adjust air pressure regulator to 80 psi (0.6 MPa, 6 bar).
5. Perform Setup procedure for dispense valve and feed system components. See **Related Manuals** on page 3.

## Motor Driven PD44 Only

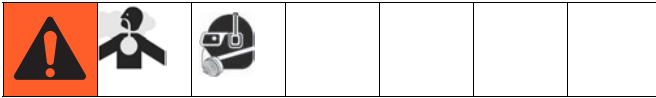

1. Connect Dispense Valve I/O, Start Options, and Motor logic cables. If level controls are installed, connect Level Controls logic cables.

### NOTICE

Feed system and main logic control system must use separate air supplies.

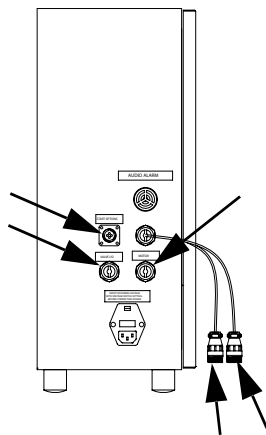

2. Adjust customer supplied air pressure regulator to 80 psi (0.6 MPa, 6 bar).
3. Perform Setup procedure for dispense valve and feed system components. See **Related Manuals** on page 3.

# Startup

**NOTE:** See **HMI Operation** starting on page 14 for detailed HMI instructions.

1. Press the Control Power On button.



2. **On Micrometer and LRT PD44s**, navigate to the Posidot<sup>®</sup> Control screen.  
**On Motor Driven PD44s**, navigate to the Metering Valve Control screen.
3. Under Posidot Mode, press the Retract button.

**NOTE: On LRT and Motor Driven PD44s**, when there is an Emergency Stop condition or the system power is lost, the shot selection resets to “0”. The operator must then select a shot.

**NOTE: On Micrometer PD44s**, skip steps 4-7.

4. Navigate to the Shot Size screen.
5. Select a shot number.
6. Navigate to the Pump Mode screen.
7. Press the Shot button to select Shot Mode.
8. Verify air pressure is set to 80 psi (5.6 bar).
9. Perform feed system startup procedure(s). See **Related Manuals** on page 3.
10. Perform dispense valve startup procedure. See **Related Manuals** on page 3.

# Dispensing Operation

**NOTE:** See **HMI Operation** on page 14 for detailed HMI instructions.

The foot switch, the “Start” button, and the optional Customer Start Signal can be used to initiate shots. These are referred to as start devices.

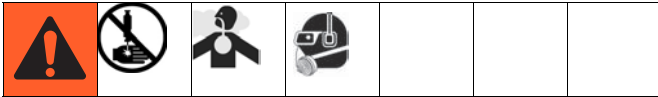

## Perform a Shot

1. **On Micrometer and LRT PD44s**, navigate to the Posidot Control screen.  
**On Motor Driven PD44s**, navigate to the Metering Valve Control screen.
2. Under Posidot Mode, press the Retract button.
3. Press the Shot button to select Shot Mode.
4. Press and release the start device to perform one shot.

## Dispense Continuously

The valve dispenses continuously until the end of the stroke is reached.

1. **On Micrometer and LRT PD44s**, navigate to the Posidot Control screen.  
**On Motor Driven PD44s**, navigate to the Metering Valve Control screen.
2. Under Posidot Mode, press the Retract button.
3. Press the Continuous button.
4. **On Micrometer and LRT PD44s**, press and release the start device. Under Posidot Mode, press the Retract button to stop dispensing and retract the metering rods.  
**On Motor Driven PD44s**, press and hold the start device to dispense continuously. Release the start device to stop dispensing and retract the metering rods.

## Retract Piston

1. **On Micrometer and LRT PD44s**, navigate to the Posidot Control screen.  
**On Motor Driven PD44s**, navigate to the Metering Valve Control screen.
2. Under Posidot Mode, press the Retract button.

## Extend Piston

1. **On Micrometer and LRT PD44s**, navigate to the Posidot Control screen.  
**On Motor Driven PD44s**, navigate to the Metering Valve Control screen.
2. Under Posidot Mode, press the Extend button.

# HMI Operation

## Screen Navigation Diagrams

### Micrometer PD44

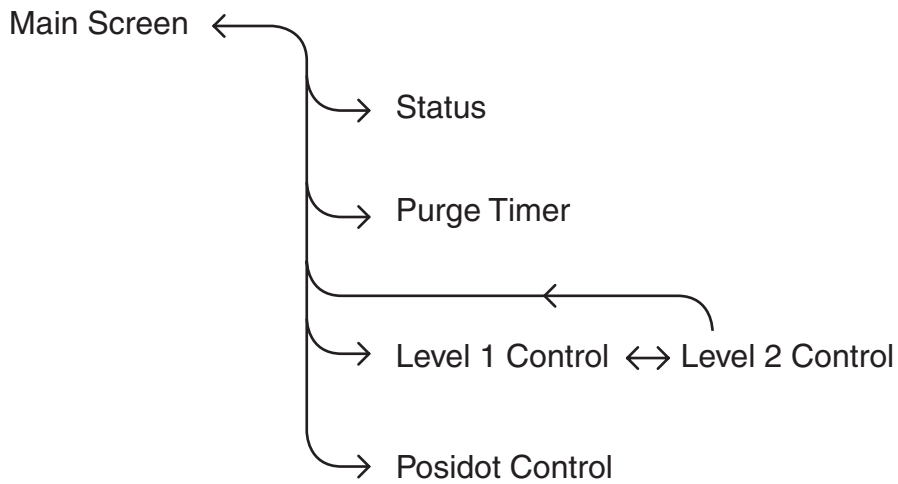

FIG. 4

### LRT PD44

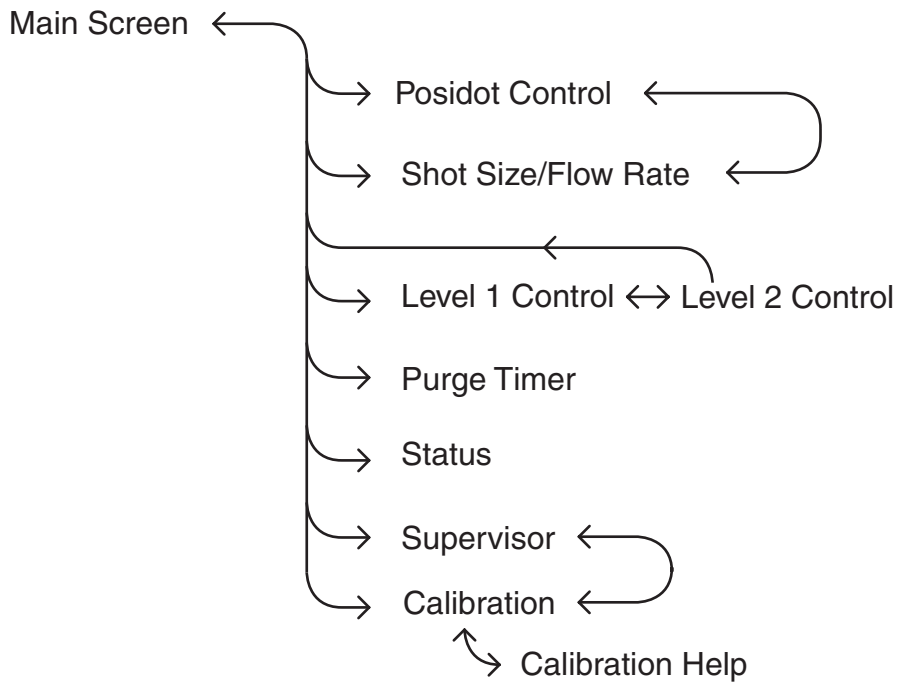

FIG. 5

### Motor Driven PD44

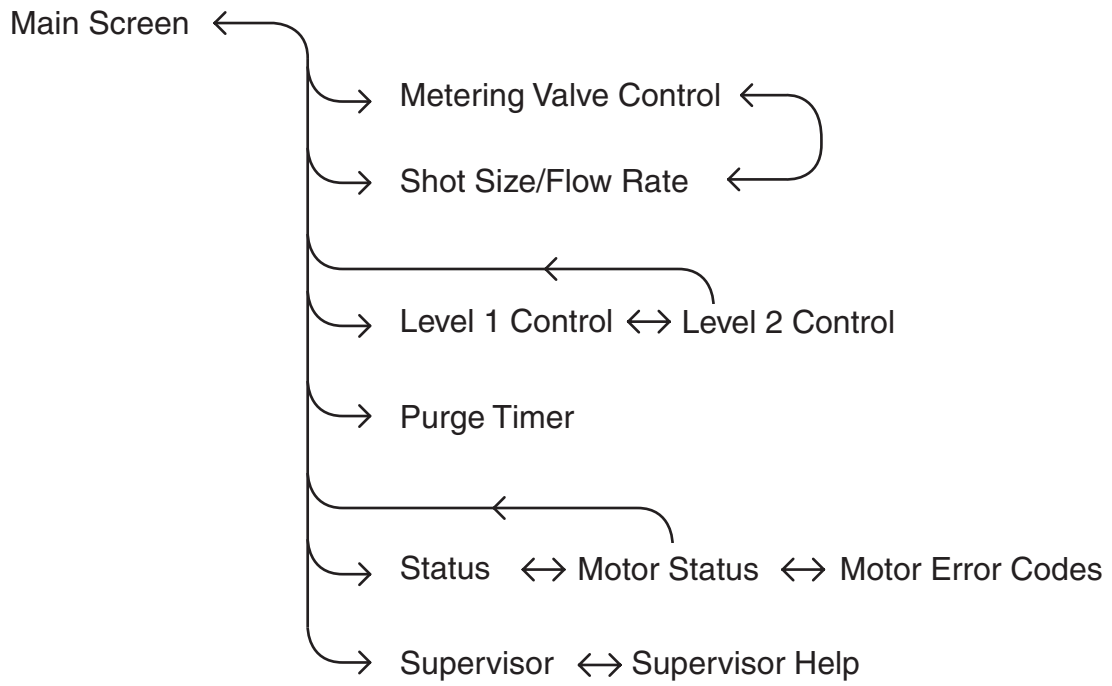
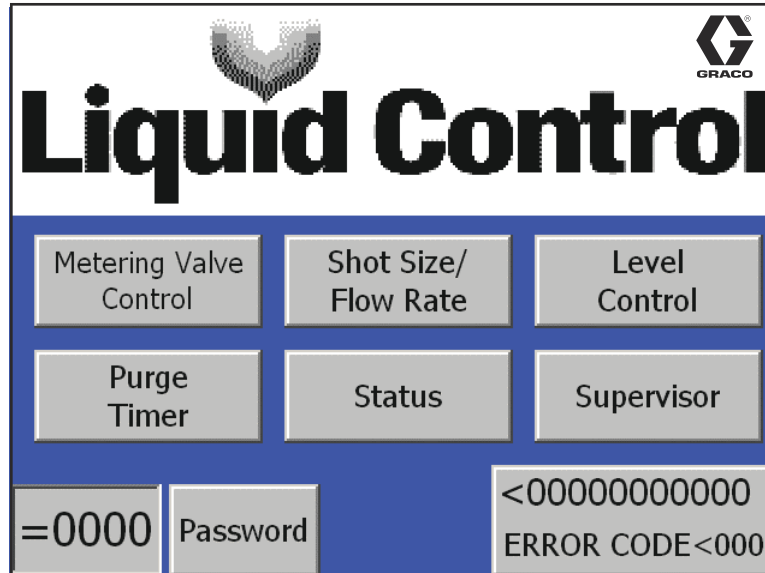

FIG. 6

## Main Screen

**NOTE:** The Error Code button is shown on every screen on the Motor Driven PD44.



*Motor Driven PD44 Main Screen shown*

### Screen Access Buttons

All buttons on the main screen except for the Password and Error Code buttons open a new specified screen. For example, pressing the “Status” button opens the Status screen. The Password and Error Code buttons are only on the Motor Driven PD44 screens.

### Password (Motor Driven PD44 only)

The password button enables the user to change values in certain screens.

To access the password press the Password Access button (shown as “=0000”). When the keyboard appears enter password “**5810**” then press the Enter key.

### Error Code (Motor Driven PD44 only)

**NOTE:** The Error Code button is shown on every screen on the Motor Driven PD44.

On all screens that it is shown, the Error Code button resets the error seen in the error string (shown as “<0000000000”) and the error code number (shown as “<000”). See the Motor Error Codes screen for more information, page 32.



## Posidot Control Screen (Micrometer PD44 and LRT PD44 only)

**NOTE:** A “1” indicates that the button is in the “ON” position. A “0” indicates that the button is in the “OFF” position.

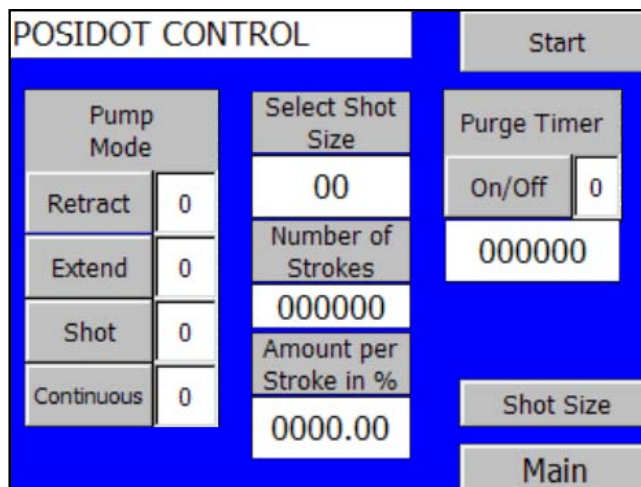

*LRT PD44 Posidot Control screen shown*

### Start button

When the Start button is pressed, the machine starts the cycle for the selected Pump Mode.

### Pump Mode

**NOTE:** The metering rods must be retracted prior to changing any setting under Pump Mode. See **Retract Piston**, page 13.

### Retract Mode

The air cylinder and pumps immediately retract and remain in the retracted position. This is used for maintenance purposes only.

### Extend Mode

The air cylinder and pumps immediately extend and remain in the extended position. This is the position that must be selected when the pump is idle for a long period of time.

### Shot Mode

The machine fully cycles the number of times displayed in the Cycle Counter field when the start device is pressed and released. The machine cycles continuously when the start device is pressed and held.

### Continuous Mode

The machine continually cycles the pumps when the START DEVICE is pressed.

### Purge Timer On /Off

See Purge Timer screen for definition, page 25.

### Dwell Timer (LRT and Motor Driven Only)

See Purge Timer screen for definition, page 25.

### Cycle Counter On /Off (Micrometer PD44 Only)

Cycle Counter not shown. See Purge Timer screen for definition, page 25.

### Select Shot Size (LRT PD44 Only)

See Shot Size screen for definition, page 20.

### Number of Strokes (LRT PD44 Only)

See Shot Size screen for definition, page 20.

### Amount per Stroke (LRT PD44 Only)

See Shot Size screen for definition, page 20.

# Metering Valve Control Screen (Motor Driven PD44 only)

**NOTE:** A “1” indicates that the button is in the “ON” position. A “0” indicates that the button is in the “OFF” position.

**NOTE:** The Error Code button is shown on every screen on the Motor Driven PD44. See the Main screen for definition.

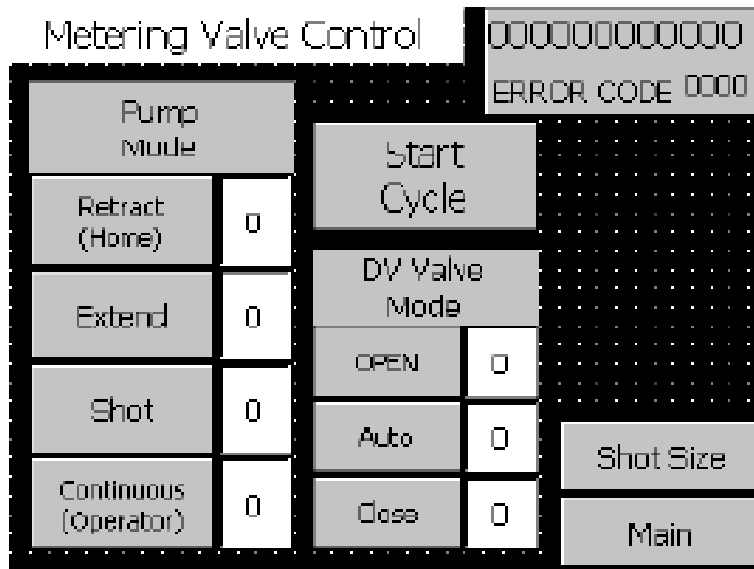

### Start button



When the Start button is pressed, the machine starts the cycle for the selected Pump Mode.

### Pump Mode

**NOTE:** The metering rods must be retracted prior to changing any setting under Pump Mode. See **Retract Piston**, page 13.

### Retract Mode

The air cylinder and pumps immediately retract and remain in the retracted position. This is used for maintenance purposes only.

### Extend Mode



The air cylinder and pumps immediately extend and remain in the extended position. This position must be selected when the pump is idle for a long period of time.

### Shot Mode

The machine cycles the number of times displayed in the Cycle Counter field when the start device is pressed and released. The machine cycles continuously when the start device is pressed and held.

### Continuous (Operator Control) Mode

In this mode, the machine to dispense while the start device is pressed. When the start device is released the metering rods retract to the home position.

**DV Valve Mode**

This mode actuates an optional dispense valve.

**OPEN**

In this mode, the dispense valve is held in the open position, allowing material to pass through.

**AUTO**

In this mode, the dispense valve opens automatically whenever the pump is cycled.

**CLOSE**

In this mode, the dispense valve is held closed.

## Shot Size Screen (LRT PD44 only)

**NOTE:** This section describes the Shot Size screen for the LRT PD44 only. See page 21 for the Motor Driven PD44 Shot Size screen.

Shot Size Screen	Shot Size 1 =000.00	Shot Size 5 =000.00	Shot Size 9 =000.00
Select Shot Size	Shot Size 2	Shot Size 6	Shot Size 10
=0	=000.00	=000.00	=000.00
Number of Strokes	Shot Size 3 =000.00	Shot Size 7 =000.00	Pump Control Main
<00000	Shot Size 4	Shot Size 8	
Amount per Stroke in %	=000.00	=000.00	
<000.00			

**NOTICE**

Erratic operation results if the shot size value entered is not greater than the absolute value of the Shot Size Offset setting. For example, if the Shot Size Offset setting is -1%, a shot size greater than 1% must be entered. See Supervisor screen, page 33.

### Shot Size 1 – 10

The Shot Size 1 - 10 buttons allow the operator to program 10 different shot sizes. Shot size is percent of stroke. Once the shot sizes are programmed the shot number can be selected using the Select Shot Size button.

To change the Shot Size 1-10 setting, perform the following steps.

1. Select one of the Shot Size 1-10 buttons. A numeric keypad appears.
2. Enter the desired material shot size volume in percent of stroke. For example, enter “150” to dispense material volume equivalent to 1.5 strokes.
3. Press the  button. The keypad disappears. The new shot size percentage appears in the Shot Size field.

### Select Shot Size button

The Select Shot Size button allows the operator to choose one of the ten preset shot sizes seen in the Shot Size 1 - 10 section.

### Number of Strokes

This displays the number of strokes needed to perform the selected shot. If the Shot Size selected is 150% then Number of Strokes displays a “2” because the machine performs two strokes at 75% of the full stroke.

### Amount per Stroke in %

This displays the percent of stroke used to perform the selected shot. If the Shot Size selected is 150% then the Amount per Stroke in % displays “75” because the machine performs 2 strokes using 75% of the full stroke length.

# Shot Size Screen (Motor Driven PD44 Only)

**NOTE:** This section describes the Shot Size screen for the Motor Driven PD44 only. See page 20 for the LRT PD44 Shot Size screen.

<000000000000 ERROR CODE<000		Shot Size (percent)	Flow Rate (mm/sec)
Select Shot Size/Flow Rate Combination  =0	1	=000.00	=0.00
	2	=000.00	=0.00
	3	=000.00	=0.00
	4	=000.00	=0.00
	5	=000.00	=0.00
	6	=000.00	=0.00
	7	=000.00	=0.00
Amount Per Stroke % <000	Number of Strokes <00000	Metering Valve Control	Main

**NOTICE**

Erratic operation results if the shot size value entered is not greater than the absolute value of the Shot Size Offset setting. For example, if the Shot Size Offset setting is -1%, a shot size greater than 1% must be entered. See Supervisor screen, page 34.

### Shot Size (percent), Flow Rate (mm/sec)

These are the 7 preset Shot Size (percent) and Flow Rate (mm/sec) values. Shot size is in percent of stroke. The preset values can be selected using Select Shot Size/Flow Rate Combination.

To edit the preset Shot Size or Flow Rate values, log-in as the supervisor. See Main Screen, page 16.

Below is the minimum and maximum field allowance for this design.

**Shot Size:**  
 Minimum = 2.5%  
 Maximum = 500.0%

**Flow Rate:**  
 Minimum = 0.50 mm/second  
 Maximum = 25.00 mm/second

### Select Shot Size/Flow Rate Combination

Use this to change the selected shot by entering a number between 1 and 7. The selected shot size and flow rate is shown in the Shot Size (percent) section and Flow Rate (mm/sec) section.

### Number of Strokes

This displays the number of shots of material when the machine is dispensing.

For example, if the purge shot size is set at 150%, Number of Strokes displays a "2", and the Amount Per Stroke % displays "75.00".

### Amount Per Stroke %

This displays the stroke per shot in percent of stroke.

For example, if the purge shot size is set at 340%, Amount Per Stroke % displays "85.00" and Number of Strokes During Purge displays a "4".

## Level 1 Control Screen

**NOTE:** The Error Code button is shown on every screen on the Motor Driven PD44. See the Main screen for definition, page 16.

**NOTE:** If 'A Tank Status' and 'B Tank Status' both display 'Levels Not Active' then the level control feature is not installed on this machine.

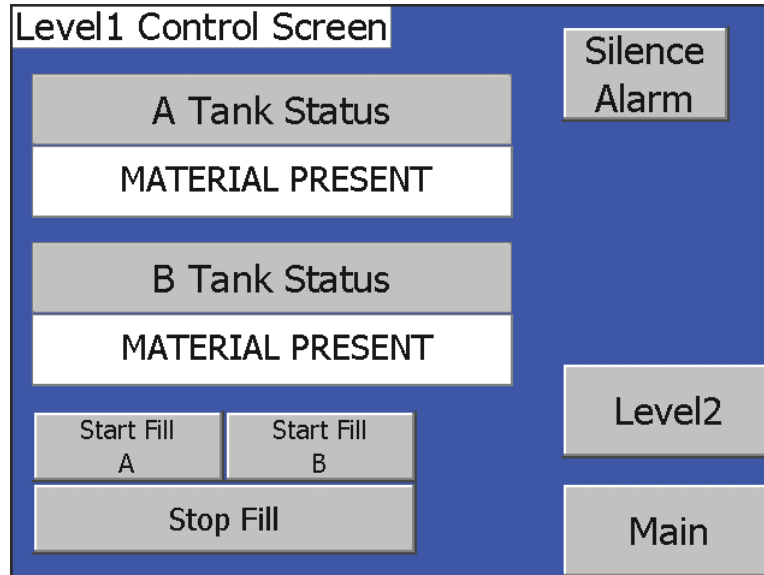

*Micrometer PD44 and LRT PD44 Level 2 Control screen shown*

### A Tank Status, B Tank Status

This displays information about each component tank filling process. The following are the possible messages.

Message	Description
Material High	The tank level is at or above the high level sensor.
Material Low	The tank level is below the low level sensor.
Filling	The tank is currently refilling in the tank refilling process.
Material Present	The tank level is between the high and the low level sensors.
Level Sensor Fault	The machine senses material at the high level sensor but not at the low level sensor.
Levels Not Active	Level sensors are not installed for the tank.
Fill Fault	The tank began refilling and the fluid level did not reach the high level sensor within the preset time entered into the Fill Timer button seen in the Level2 Control screen. Tank has stopped refilling.

### Start Fill A, Start Fill B button

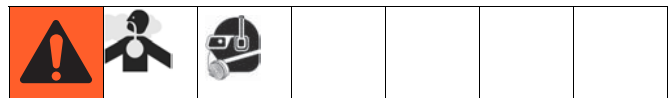

When this button is pressed the transfer pump fills the tank until the material level reaches the high level sensor on that tank.

**NOTE:** The Start Fill A, Start Fill B and the Stop Fill buttons are inoperable if the high level automatic tank refilling feature was not purchased with this machine.

### Stop Fill button

This button stops the automatic tank refilling process for both the A and B component material tanks.

### Silence Alarm button

This button silences the audible alarm when pressed.

## Level 2 Control Screen

**NOTE:** A “1” indicates that the button is in the “ON” position. A “0” indicates that the button is in the “OFF” position.

**NOTE:** The Error Code button is shown on every screen on the Motor Driven PD44. See the Main screen for definition, page 16.

**NOTE:** In the Level 1 Control Screen, if ‘A Tank Status’ and ‘B Tank Status’ both display ‘Levels Not Active’ then the level control feature is not installed on this machine. Press the Main button to exit from this screen.

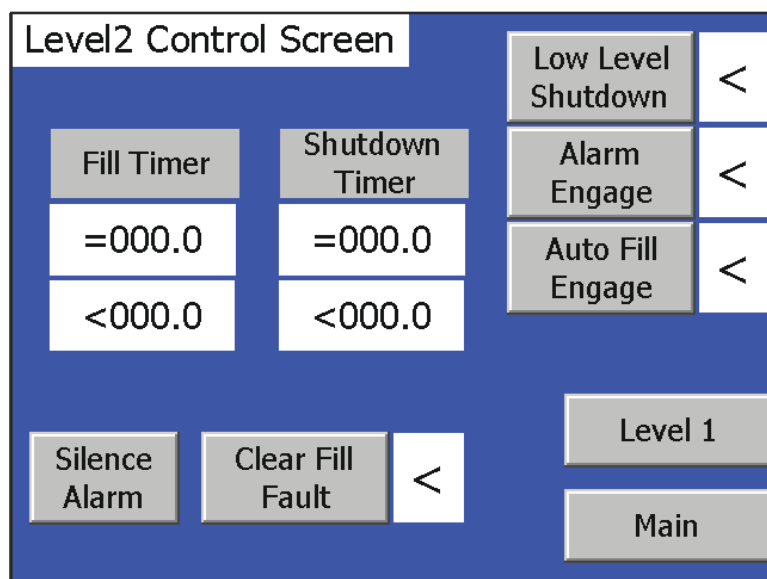

*Micrometer PD44 and LRT PD44 Level 1 Control screen shown*

### Low Level Shutdown button

When this button displays ‘1’ and the material level of either the ‘A’ component tank or the ‘B’ component tank goes below the low level sensor, the machine shuts down. To recover, refill the component tank with material to above the low level sensor. When ‘0’ is displayed, the low level shutdown feature is disabled.

### Alarm Engage button

When this button displays ‘1’ and the material level of either the ‘A’ component tank or the ‘B’ component tank goes below the low level sensor the audible alarm is activated.

### Auto Fill Engage button

When this button displays ‘1’ the automatic filling function is activated.

### Clear Fill Fault button

This button clears the Fill Timer Fault message displayed in the corresponding ‘A Tank Status’ or ‘B Tank Status’ field in the Level 1 Control screen.

### Silence Alarm button

Press this button to silence the low fluid level audible alarm. The audible alarm will be activated again when the low level condition reoccurs.

### Shutdown Timer button/indicator

**NOTE:** If the level control option has not been purchased the Shutdown Timer button is disabled.

This changes the delay before the Fill Timer Fault message is displayed in the corresponding 'A Tank Status' or 'B Tank Status' field on the Level 1 Control screen. If the material level is below the low level sensor for more than the duration of the Shutdown Timer setting, the machine shuts down.

To change the Shutdown Timer setting, perform the following steps.

1. Select the Shutdown Timer button (shown as "=00000"). A numeric keypad appears.
2. Enter the desired Shutdown Timer setting in tenths of a second.

**NOTE:** For example, if 15 is entered, the shutdown time is 1.5 seconds.

3. Press the  button. The new Shutdown Timer setting is shown.

**NOTE:** The current time of the Shutdown Timer is shown by "<00000". This counts up to the preset time.

### Fill Timer

**NOTE:** If the automatic refilling option has not been purchased the Fill Timer function is disabled.

This changes the delay before the Fill Timer Fault message is displayed to the corresponding 'A Tank Status' or 'B Tank Status' field in the Level 1 Control screen. If the material level reaches the tank high level sensor before the preset fill time elapses, the 'Tank High Level' message is displayed in the Tank Status field and the Fill Timer is reset. If the preset fill time expires before material reaches the high level sensor, "Fill Timer Fault" appears in the Level1 Control Screen.

To change the Fill Timer setting, perform the following steps.

1. Select the Fill Timer button (shown as "=00000"). A numeric keypad appears.
2. Enter in the Fill Timer time in tenths of a second.

**NOTE:** For example, if 15 is entered, the Fill Timer setting is 1.5 seconds.

3. Press the  button. The new Fill Timer setting appears in the Fill Timer field.

**NOTE:** The current Fill Timer time is shown by "<00000". This counts up to the preset time.



# Purge Timer Screen

**NOTE:** The Error Code button is shown on every screen on the Motor Driven PD44. See the Main screen for definition, page 16.

**NOTE:** On the Micrometer PD44, the “Purge Timer screen” is named the “Timer/Counter Screen.”

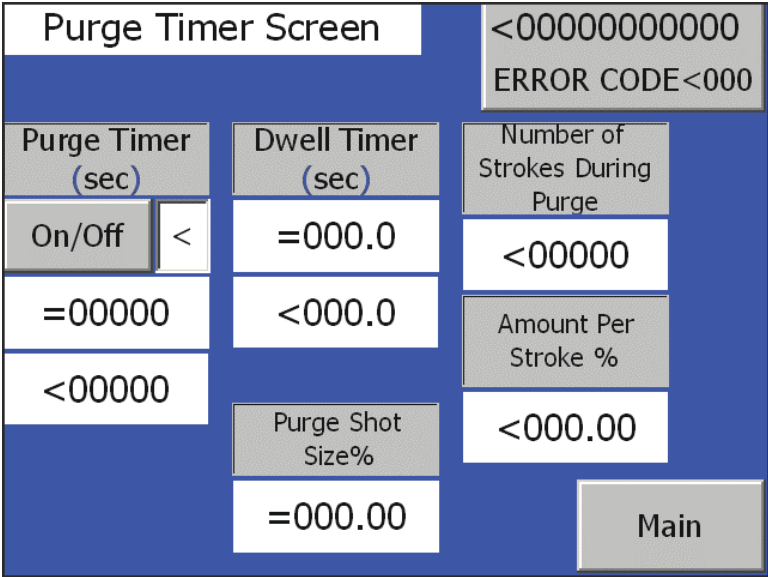

Motor Driven PD44 Purge Timer Screen Shown

### Cycle Counter On/Off button (Micrometer PD44 Only, Not Shown)

The Cycle Counter switch is used to enable/disable the cycle counter.

**OFF:** The Cycle Counter is disabled.

**ON:** If Shot Mode is selected, when the Cycle Counter is enabled the number of cycles entered are dispensed.

To change the Cycle Counter value, perform the following steps.

1. Select the Cycle Counter button. A numeric keypad appears.
2. Enter in the desired number of counts for the Cycle Counter.
3. Press the Enter button. The current number of cycles appears in the Cycle Counter field.

### Purge Timer On /Off

Always set the dwell/alarm timer to a value that will give the user adequate warning that the machine is about to dispense a purge shot. See <b>Dwell / Alarm Timer</b> section on page 26.						

The Purge Timer On/Off switch is used to enable/disable the Purge Timer.

**OFF:** The Purge Timer is disabled.

**ON:** The Purge Timer is enabled. The machine initiates a purge shot when the purge timer expires provided the fluid ball valves are open, Shot Mode is selected, and no errors exist.

### Enter Purge Time Button

The Enter Purge Time button is shown as “=000.0” below the Purge Timer On /Off button. The Enter Purge Time button allows the operator to set the required time between cycles. When the Purge Timer switch is in the ON position and the Pump Mode switch is in the Shot or Operator Control position, the purge timer unit counts up to the preset time. When it reaches the preset time, a purge shot is initiated.

The timer then automatically resets and continues with the sequence of cycling and resetting. It continues until the Purge Timer is turned to the OFF position.

To change the Purge Timer setting, perform the following steps.

1. Select Purge Timer button. A numeric keypad appears.
2. Enter the desired purge time in seconds. Use the “.” button to enter tenths of a second.
3. Press the  button. The Purge Timer screen appears. The new purge time appears in the Purge Timer button.

**NOTE:** The current Purge Timer time is shown in the bottom text box below the Purge Timer button.

### Calculating the Purge Timer Setting





If the shot size is larger than the mixer volume, set the timer for one-half the gel time of the material. If the shot size is smaller, use the following formula to determine the Purge Timer setting.

$$\frac{\text{Gel Time X Shot Size}}{2 \text{ X Mixer Volume}} = \text{Timer Setting}$$

For example, with mixer volume = 13.3cc, shot size = 10cc, gel time = 10 minutes, use the following equation.

$$\frac{10 \text{ min X } 10 \text{ cc}}{2 \text{ X } 13.3 \text{ cc}} = \frac{100 \text{ cc*min}}{26.6 \text{ cc}} = 3.76 \text{ min}$$

### Dwell / Alarm Timer

						
Always set the dwell/alarm timer to a value that will give the user adequate warning that the machine is about to dispense a purge shot.						

This changes the duration that the audible alarm is active prior to the purge shot being initiated.

To change the Dwell Timer, perform the following steps.

1. Select the Dwell Timer button. A numeric keypad appears.
2. Enter the desired Dwell Timer time in seconds. Use the “.” button to enter tenths of seconds.
3. Press the  button. The new Dwell Timer time appears in the Dwell Timer field.

**NOTE:** The current Dwell Timer time is shown by <000.0.

### Purge Shot Size % button (LRT and Motor Driven PD44 only)

This button shows the Shot Size volume in percent of stroke. This volume is dispensed during the ratio check.

To change the Purge Shot Size % volume, perform the following steps.

1. Select Purge Shot Size % button. A numeric keypad appears.
2. Enter the desired material shot size volume.
3. Press the  button. The Purge Timer screen appears. The new shot size percentage appears in the Purge Shot Size % field.

### Number of Strokes During Purge button/indicator (LRT and Motor Driven PD44 only)

This displays the number of strokes used during the purge shot.

For example, if the purge shot size is set at 150%, Number of Strokes During Purge displays “2” and Amount Per Stroke % displays “75”.

**Amount Per Stroke % (LRT and Motor Driven PD44 only)**

This displays the percent of the stroke used during a shot.

For example, if the shot size is set at 150%, Number of Strokes During Purge displays "2" and Amount Per Stroke % displays "75".

## Status Screen

**NOTE:** A “1” indicates that the button is in the “ON” position. A “0” indicates that the button is in the “OFF” position.

**NOTE:** The Error Code button is shown on every screen on the Motor Driven PD44. See the Main screen for definition, page 16.

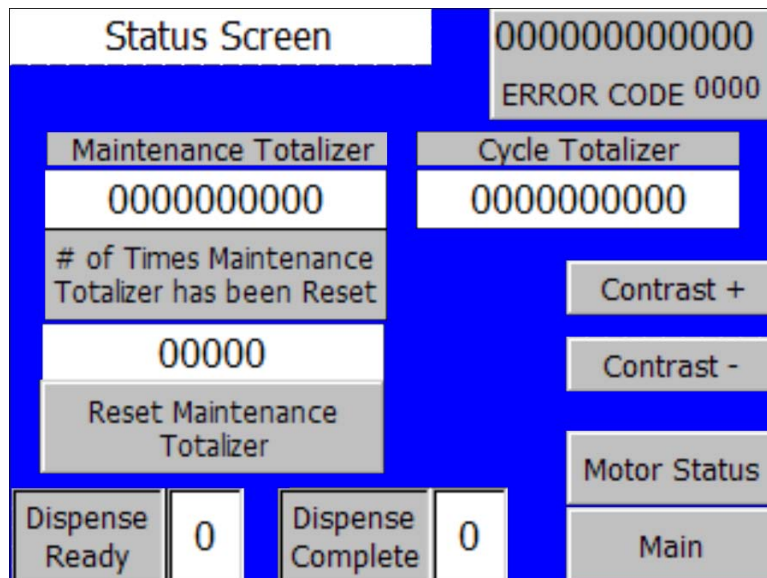

*Micrometer PD44 and LRT PD44 Status Screen Shown*

### Maintenance Totalizer

This counter increments each time the machine cycles. Press the Reset Maintenance Totalizer button to reset. This counter is used for maintenance purposes.

### # Of Times Maintenance Totalizer has been Reset

This counter increments each time the Reset Maintenance Totalizer button is pressed.

### Reset Maintenance Totalizer button

This button resets the Maintenance Totalizer.

### Cycle Totalizer

This counter increments each time the machine cycles.

### Number of Strokes (Motor Driven PD44 Only, not shown)

This displays the number of strokes needed to perform the currently selected shot size. If the selected shot size is 150%, Number of Strokes displays a “2”.

### Amount per Stroke in % (Motor Driven PD44 Only, not shown)

This displays the amount of stroke used to perform the currently selected shot. If the shot size is 150%, Amount per Stroke in % displays “75%”.

### Dispense Ready

This displays “1” if the metering rods are loaded with material and ready to dispense. It displays a “0” if the metering tube is reloading or at the end of the dispense cycle. Customer Signal Integration Kit 80/2450/CS/50, which uses this output, can be ordered separately. The Customer Signal Integration Kit is standard on Motor Driven PD44s.

**Dispense Complete**

This displays “1” if the metering rods are reloaded with material or at the end of the dispense cycle, and displays a “0” if the metering tube is loaded with material and ready to dispense. Customer Signal Integration Kit 80/2450/CS/50, which uses this output, can be ordered separately. The Customer Signal Integration Kit is standard on Motor Driven PD44s.

**Contrast + button**

This button increases the contrast of the screen.

**Contrast - button**

This button decreases the contrast of the screen.

**PX-CSV Reload**

This displays the status of the reload spool proximity switch. If this displays a “1” the switch is activated and if this displays a “0” the switch is deactivated. See Component Identification section in dispense valve manual. See **Related Manuals** on page 3.

**PX-OSV Dispense**

This displays the status of the dispense spool proximity switch. If this displays a “1” the switch is activated. If this displays a “0” the switch is deactivated. See component identification section in dispense valve manual. See **Related Manuals** on page 3.

**PLC Program (Micrometer and LRT PD44 only)**

This gives the currently installed PLC program version and revision level.

**HMI Program (Micrometer and LRT PD44 only)**

This gives the currently installed HMI program version and revision level.

## Motor Status Screen (Motor Driven PD44 only)

**NOTE:** A “1” indicates that the button is in the “ON” position. A “0” indicates that the button is in the “OFF” position.

**NOTE:** The Error Code button is shown on every screen on the Motor Driven PD44. See the Main screen for definition, page 16.

Motor Status		<00000000000 ERROR CODE<000	
Shot Mode	Reload Mode	Oper. Mode	
Step #	Step #	Step #	
<0	<0	<0	
CSV Switch	<	Motor Position (STEPS) <000000000	
OSV Switch	<		
Home Switch	<		
Upper Switch	<		
Lower Switch	<		
Shot Size (mm)		Back	
<000000.00		Motor Error Codes	
Flow Rate (mm/sec)		Main	
<000000.00			

To navigate to the Motor Status screen, press the “Motor Status” button on the Status screen.

### CSV Switch (Closed Spool Valve Switch)

This displays “1” when the spool valve is in the closed or reload position.

### OSV Switch (Open Spool Valve Switch)

This displays “1” when the spool valve is in the open or dispense position.

### Home Switch (Home Limit Switch)

This displays “1” when the metering valve rod home switch is activated.

### Upper Switch (Upper Over Limit Switch, Extend)

This displays “1” when the metering valve rod upper over-travel limit switch is activated. The dispense valve is in the most-retracted position.

### Lower Switch (Lower Over Limit Switch, Retract)

This displays “1” when the metering valve rod lower over-travel limit switch is activated. The dispense valve is in the most-extended position. Put the dispense valve in this position when it is idle for a long period of time.

### Motor Position (Steps)

This gives the motor step position in terms of transducer steps.

### Shot Size %

This shows the Shot Size volume in percent of stroke.

### Flow Rate (mm/sec)

This allows the operator to view the current flow rate in millimeters per second.

**Shot Mode Step #**

This gives the current step in the shot mode program.  
This is used for troubleshooting.

**Reload Mode Step #**

This gives the current step in the reload mode program.  
This is used for troubleshooting.

**Oper. Mode Step #**

This gives the current step in the operator mode program. This is used for troubleshooting.

## Motor Error Codes Screen (Motor Driven PD44 Only)

These screens give descriptions of the motor error codes.

Error Codes:	
Error Code	Description
0	No error
1	Aborted by user
2	Configuration error      Call LCC For Technical Help
3	Illegal command          Call LCC For Technical Help
4	Aborted due to no valid configuration
5	Aborted due to no user power
6	Aborted due to no defined reference point
7	Aborted due to STOP input active
8	Aborted due to UPPER LIMIT input active
9	Aborted due to LOWER INPUT input active
10	Aborted due to problem executing motion
11	No profile block configured for specified profile

Page 2      Back

Error Codes:	
Error Code	Description
12	Illegal operation mode
13	Operation mode not supported for this command
14	Illegal number of steps in profile block
15	Illegal direction change
16	Illegal distance
17	RPS trigger occurred before target speed reached
18	Insufficient RPS active region width
19	Speed out of range
20	Insufficient distance to perform desired speed change
21	Illegal position
22	Zero position unknown
66	Spool shift to dispense did not occur
130	Position Module is not enabled(Occurs at Power Up)

Back



## Supervisor Screen (LRT PD44 Only)

**NOTE:** This section describes the Supervisor screen for the LRT PD44 only. See page 34 for the Motor Driven PD44 Supervisor screen.

<b>Supervisor Screen</b>		<b>Enter Password</b>
<b>Pump Reload Position</b>		<b>=0000</b>
<b>=000.00</b>		<b>ENTER DATA</b>
<b>Current</b>	<b>&lt;000.00</b>	
<b>Shot Size Offset</b>		<b>Calibration</b>
<b>=000.00</b>		<b>Main</b>
<b>Current</b>	<b>&lt;000.00</b>	

### Pump Reload

Pump Reload sets a transducer point where the machine will reload. The point is relative to the rod stroke mechanical limits.

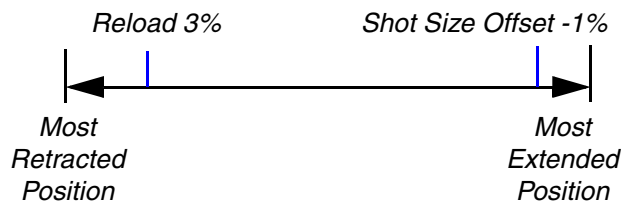

To change the Pump Reload setting, perform the following steps.

1. Press Enter Password button.
2. Enter password.
3. Press the Enter button.
4. Press the Pump Reload Position button.
5. Enter the desired reload position.
6. Press the Enter button.
7. Press the Enter Data button.

### Shot Size Offset Button

The Shot Size Offset button sets the transducer point where the metering rods will retract. The factory setting is -1.

To change the Shot Size Offset setting, perform the following steps.

1. Press Enter Password button.
2. Enter password.
3. Press the Enter button.
4. Press the Shot Size Offset button.
5. Enter the desired Shot Size Offset.
6. Press the Enter button.
7. Press the Enter Data button.

## Supervisor Screen (Motor Driven PD44 Only)

**NOTE:** This section describes the Supervisor screen for the Motor Driven PD44 only. See page 34 for the LRT PD44 Shot Size screen.

**NOTE:** A “1” indicates that the button is in the “ON” position. A “0” indicates that the button is in the “OFF” position.

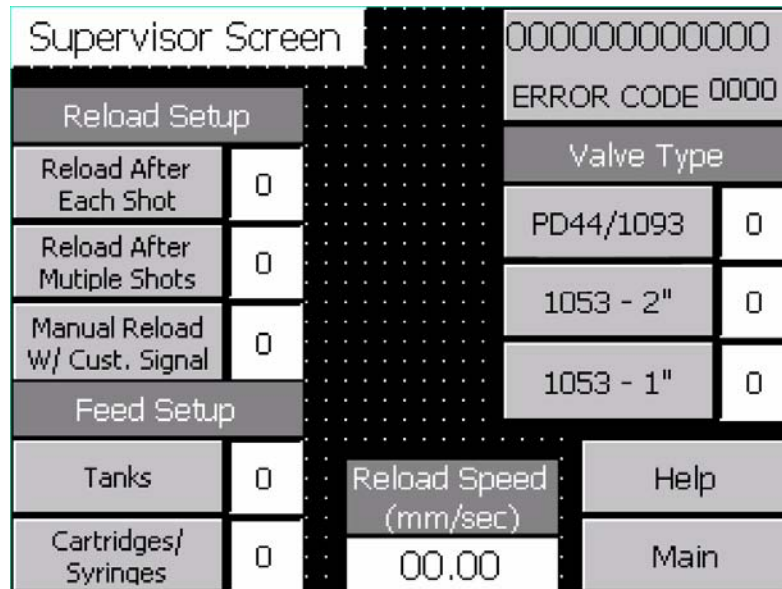

**NOTE:** To change the values on this screen, log-in as the supervisor. See Main Screen, page 16.

### Error Code button

This button resets the error in the error string (shown as “<0000000000”) and the error code number (shown as “<000”). See the Motor Error Code screen for more information, page 32.

### Reload Setup

Only one of the three Reload Setup Options can be enabled at any given time.

### Reload After Each Shot button

In this mode, the metering rods retract after every shot. This is the default system setup.

### Reload After Multiple Shots button

In this mode, the metering rods retract only when the metering rods are about to reach the end of the stroke. This feature is only available when in Operator Control mode.

For example, if the selected shot size is 30% of the metering rods stroke, three shots will be taken (90% of the stroke) then the metering rods will retract. The rods retract after three shots because it cannot do another shot without going over 100% stroke. If the selected shot size is greater than 50% of the metering rods stroke, the metering rods will retract after every shot.

### Manual Reload W/ Customer Signal button

In this mode, the customer must send a signal to reload the valve before the lower switch is activated. Otherwise, the dispense valve will initiate a shot using the selected shot size and flow rate combination.

**NOTE:** This can be linked with a PLC input for system integration. See the logic drawings for more information.

### Reload Speed (mm/sec) button

This allows the operator to change the retract or reload speed in millimeters per second.

### Feed Setup

This allows the operator to choose the low level setting for the feed system with tanks or a feed system with cartridge or syringes. This inverts the switch function in the PLC logic.

## Supervisor Help Screen (Motor Driven PD44 Only)

This screen describes the various reload and shot options in the Supervisor screen.

To get to the Setup Help screen, press the “Help” button on the Supervisor screen.

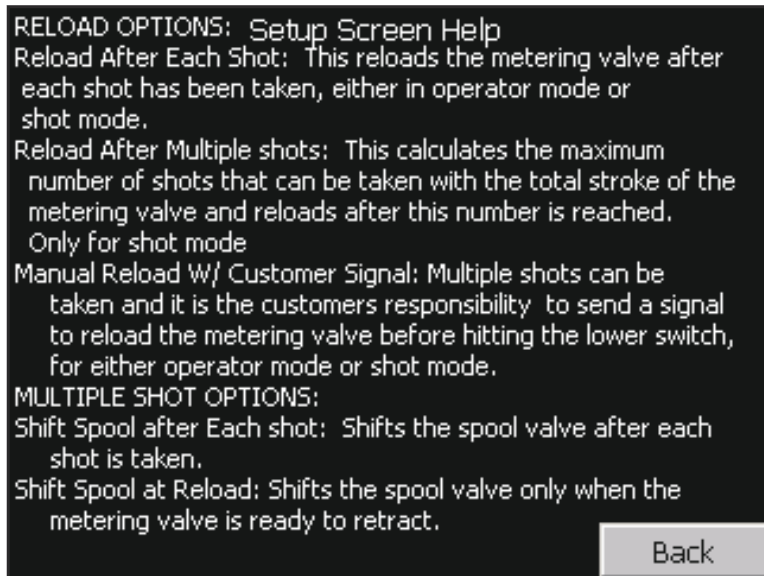

RELOAD OPTIONS: Setup Screen Help  
Reload After Each Shot: This reloads the metering valve after each shot has been taken, either in operator mode or shot mode.  
Reload After Multiple shots: This calculates the maximum number of shots that can be taken with the total stroke of the metering valve and reloads after this number is reached.  
Only for shot mode  
Manual Reload w/ Customer Signal: Multiple shots can be taken and it is the customers responsibility to send a signal to reload the metering valve before hitting the lower switch, for either operator mode or shot mode.

MULTIPLE SHOT OPTIONS:  
Shift Spool after Each shot: Shifts the spool valve after each shot is taken.  
Shift Spool at Reload: Shifts the spool valve only when the metering valve is ready to retract.

Back

## Calibration Screen (LRT PD44 Only)

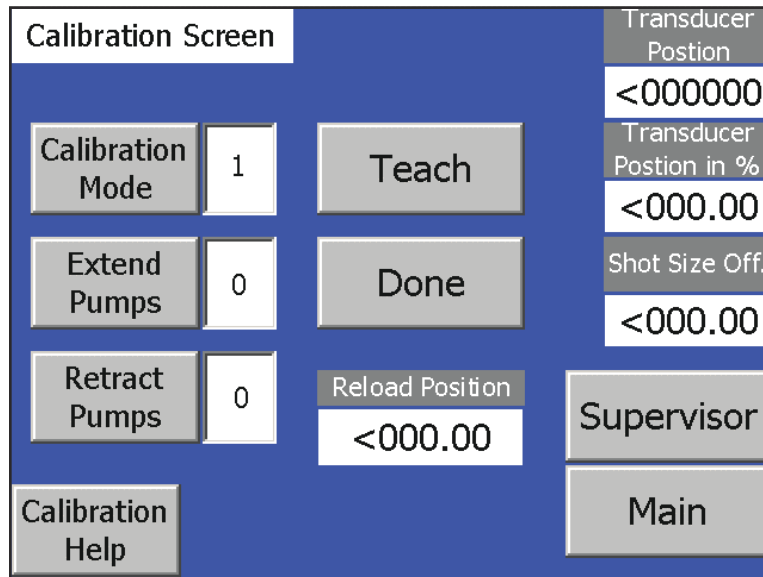

### Calibrate Mode button

When this button is selected machine calibration starts.

### Extend Pumps button



This extends the air cylinder for the calibration sequence. The most-extended position is recorded when the Teach button is then pressed.

### Retract Pumps button

This retracts the air cylinder for the calibration sequence. The most-retracted position is recorded when the Teach button is then pressed.

### Teach button

This “teaches” or stores various data collected during calibration mode.

### Done button

This button exits Calibration mode.

### Transducer Position

This shows the transducer position in transducer units.

### Transducer Position in %

This shows the transducer position in percent of stroke.

To calibrate the pumps, perform the following steps.

1. From the Calibration screen, select Calibration Mode.
2. Press the Extend Pumps button. Pumps extend.
3. Press the Teach button.
4. Press the Retract Pumps button. Pumps retract.
5. Press the Teach button.
6. Press the Done button.

### Shot Size Offset

The Shot Size Offset allows the operator to view the shot size offset percentage. The factory default is -1%. See the Supervisor screen, page 33.

### Reload Position

Reload Position allows the operator to view the reload position. The factory setting is 3%.

## Calibration Screen Help

This screen describes the calibration procedure.

Calibration Screen Help

Calibration is used to establish the pump position in units of percent. Perform the Calibration procedure after any pump maintenance.

Previous Screen

Calibration Procedure  
Refer to Machine Manual for detailed information

- 1) From the Posidot control Screen select Shot Mode.
- 2) From the Calibration Screen select Calibration Mode.
- 3) Press the Extend Pumps button. (Pumps will move forward)
- 4) Press the Teach button.
- 5) Press the Retract Pumps button. (Pumps will move back)
- 6) Press the teach button.
- 7) Press the Done button.
- 8) Return to Posidot Control screen select Pump Mode.

# Pressure Relief Procedure

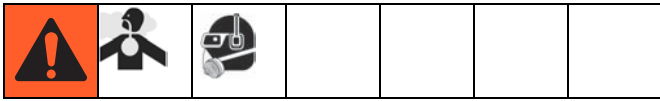

1. Turn main air supply shut-off/bleed valve to the off position. This will bleed air from the system.
2. Perform feed system pressure relief procedure. See **Related Manuals** on page 3.
3. Perform dispense valve pressure relief procedure. See **Related Manuals** on page 3.

# Shutdown



1. **On Micrometer and LRT PD44s**, go to the Posidot Control screen.  
**On Motor Driven PD44s**, go to the Metering Valve Control screen.
2. Press the Retract button.
3. Press the Extend button.
4. Press the Emergency Stop button. Ensure everything is off.
5. Twist Emergency Stop to reset.
6. Perform **Pressure Relief Procedure**.
7. Perform feed system shutdown procedure. See **Related Manuals** on page 3.
8. Perform dispense valve shutdown procedure. See **Related Manuals** on page 3.

# Optional Customer Inputs

## Micrometer PD44 and LRT PD44

Name	Description
Ready to Dispense Signal (Output)	In Shot Mode, changes state when pump is retracted and LS-EXT is tripped.
Cycle-Complete (Output)	In Shot Mode, changes state for one second after the retract switch is tripped.
Customer Start (Input)	In any mode, operates in parallel to the footswitch. Provide a dry contact closure between black and white wires on the customer signal cable to actuate machine.

## Motor Driven PD44

Name	Description
Customer Start (Input)	When a momentary contact closure is applied to this input, the start device is activated.
Customer Purge Start (Input)	When a momentary contact closure is applied to this input, the purge shot is activated.
Customer SS/FR Bit 1,2,3 (Input)	When these inputs are activated in the proper sequence, the machine activates the Shot Size and Flow Rate Combination seen on the Shot Sizes screen. See the machine logic drawings for more information.
Customer Signal Done (Output)	This output activates for 2 seconds after the dispense cycle is complete.
Customer Signal Dispense Ready (Output)	This output is active when the machine is in the Shot Mode and the dispense valve is retracted and loaded with material. This output deactivates when the dispense valve is dispensing or if the machine is not in the shot mode.
Customer Signal Time to Purge (Output)	If the Manual Reload W/ Customer Signal button under the Supervisor screen is selected, this output is active when it is time for the machine to take a purge shot. <b>NOTE:</b> The dispense valve will not perform a purge shot until the start device is activated.
Customer Signal Open Auxiliary Dispense Valve (Output)	This is to be used only when there is a metering valve feeding an on/off type dispense valve. This signal is used to open and close the dispense valve.
Customer Signal Reload (Input)	When in customer reload mode, after each shot the dispense "Done" signal is turned on for 2 seconds. During this time the customer can toggle the customer reload signal to reload the system. If the timer expires, the machines assumes the customer does not want to reload and finishes the sequence then turns on the ready signal and does not allow another reload until after the next shot.

# Maintenance





**NOTE:** If material is leaking, see **Troubleshooting** on page 40.

See **Related Manuals** on page 3 for dispense valve and feed system maintenance schedule and procedures.

## Air-Water Separator/Filter

Drain water once a shift or as necessary.

# Troubleshooting

						
Perform <b>Pressure Relief Procedure</b> before performing any troubleshooting procedure.						

## All Machines

Problem	Cause	Solution
Dispense valve stalling and no material being dispensed despite adequate input pressure	Blocked mixer	Check mixer for cured material, replace mixer as required
	Flow control valve closed	Open
Dispense valve not discharging normal or full volume	Low material level in reservoirs	Fill material reservoirs and prime the machine
	Air in material tanks	Fill reservoirs and prime machine
Material leaks past spool valves	Spool valve worn or damaged	Replace the spool valve and sleeve
Improper material mixing	Mixer not clean or free	Remove and replace the mixer
Material leaks around mixer while dispensing	Cured material in mixer	Check mixer for cured material, replace mixer

## Motor Driven PD44 Only

Problem	Cause	Solution
The horn beeps after each shot	Dispense is longer than the dispense limit timer	Check mixer for cured material
The horn beeps continuously	If the low level sensors are on, the system may be low on material	Check level screen for low level condition, if low level condition is present, fill tank with material



# Technical Data

Maximum Ambient Temperature.....	110°F (43°C)
Maximum Operating Temp.....	150°F (65°C)
Maximum Air Working Pressure.....	100 psi (0.7 MPa, 7 bar)
Supplied Air Requirements.....	1 to 3 cfm at 80 psi to 100 psi
Electrical Requirements.....	120/240V, 50/60 Hz
Fuses Required.....	<i>Micrometer and LRT PD44 Control Box:</i> 5 x 20 mm, 2A, time delay (Graco part 81/1053-2/11, Qty = 1) <i>Motor Driven PD44 Control Box:</i> 5 x 20 mm, 10A, fast, type F, 250 VAC (Graco part V-21610P, Qty = 2)
Maximum Amperage.....	<i>Micrometer and LRT PD44 Control Box:</i> 2 amps <i>Motor Driven PD44 Control Box:</i> 10 amps
Dimensions (H x L x W).....	<i>Micrometer and LRT PD44 Control Box:</i> 13 in. x 12 in. x 15 in. (330 mm x 305 mm x 381 mm) <i>Motor Driven PD44 Control Box:</i> 20 in. x 8 in. x 20 in. (508 mm x 203 mm x 508 mm)
Weight.....	<i>Micrometer and LRT PD44 Control Box:</i> 30 lb (13.6 kg) <i>Motor Driven PD44 Control Box:</i> 60 lb (27.2 kg)

# Graco Standard Warranty

Graco warrants all equipment referenced in this document which is manufactured by Graco and bearing its name to be free from defects in material and workmanship on the date of sale to the original purchaser for use. With the exception of any special, extended, or limited warranty published by Graco, Graco will, for a period of twelve months from the date of sale, repair or replace any part of the equipment determined by Graco to be defective. This warranty applies only when the equipment is installed, operated and maintained in accordance with Graco's written recommendations.

This warranty does not cover, and Graco shall not be liable for general wear and tear, or any malfunction, damage or wear caused by faulty installation, misapplication, abrasion, corrosion, inadequate or improper maintenance, negligence, accident, tampering, or substitution of non-Graco component parts. Nor shall Graco be liable for malfunction, damage or wear caused by the incompatibility of Graco equipment with structures, accessories, equipment or materials not supplied by Graco, or the improper design, manufacture, installation, operation or maintenance of structures, accessories, equipment or materials not supplied by Graco.

This warranty is conditioned upon the prepaid return of the equipment claimed to be defective to an authorized Graco distributor for verification of the claimed defect. If the claimed defect is verified, Graco will repair or replace free of charge any defective parts. The equipment will be returned to the original purchaser transportation prepaid. If inspection of the equipment does not disclose any defect in material or workmanship, repairs will be made at a reasonable charge, which charges may include the costs of parts, labor, and transportation.

**THIS WARRANTY IS EXCLUSIVE, AND IS IN LIEU OF ANY OTHER WARRANTIES, EXPRESS OR IMPLIED, INCLUDING BUT NOT LIMITED TO WARRANTY OF MERCHANTABILITY OR WARRANTY OF FITNESS FOR A PARTICULAR PURPOSE.**

Graco's sole obligation and buyer's sole remedy for any breach of warranty shall be as set forth above. The buyer agrees that no other remedy (including, but not limited to, incidental or consequential damages for lost profits, lost sales, injury to person or property, or any other incidental or consequential loss) shall be available. Any action for breach of warranty must be brought within two (2) years of the date of sale.

**GRACO MAKES NO WARRANTY, AND DISCLAIMS ALL IMPLIED WARRANTIES OF MERCHANTABILITY AND FITNESS FOR A PARTICULAR PURPOSE, IN CONNECTION WITH ACCESSORIES, EQUIPMENT, MATERIALS OR COMPONENTS SOLD BUT NOT MANUFACTURED BY GRACO.** These items sold, but not manufactured by Graco (such as electric motors, switches, hose, etc.), are subject to the warranty, if any, of their manufacturer. Graco will provide purchaser with reasonable assistance in making any claim for breach of these warranties.

In no event will Graco be liable for indirect, incidental, special or consequential damages resulting from Graco supplying equipment hereunder, or the furnishing, performance, or use of any products or other goods sold hereto, whether due to a breach of contract, breach of warranty, the negligence of Graco, or otherwise.

## **FOR GRACO CANADA CUSTOMERS**

The Parties acknowledge that they have required that the present document, as well as all documents, notices and legal proceedings entered into, given or instituted pursuant hereto or relating directly or indirectly hereto, be drawn up in English. Les parties reconnaissent avoir convenu que la rédaction du présente document sera en Anglais, ainsi que tous documents, avis et procédures judiciaires exécutés, donnés ou intentés, à la suite de ou en rapport, directement ou indirectement, avec les procédures concernées.

# Graco Information

For the latest information about Graco products, visit [www.graco.com](http://www.graco.com).

**TO PLACE AN ORDER**, contact your Graco distributor or call to identify the nearest distributor.

**Toll Free:** 1-800-746-1334 **or Fax:** 330-966-3006

*All written and visual data contained in this document reflects the latest product information available at the time of publication.  
Graco reserves the right to make changes at any time without notice.*

*For patent information, see [www.graco.com/patents](http://www.graco.com/patents)*

*Original instructions. This manual contains English. MM 313877*

**Graco Headquarters:** Minneapolis  
**International Offices:** Belgium, China, Japan, Korea

**GRACO INC. AND SUBSIDIARIES • P.O. BOX 1441 • MINNEAPOLIS MN 55440-1441 • USA**

Copyright 2009, Graco Inc. All Graco manufacturing locations are registered to ISO 9001.

[www.graco.com](http://www.graco.com)  
Revised July 2013